



Bone Surgery

Orthopädie

Cirurgía Para Huesos

Chirurgie Osseuse

www.surginor.no

SurgiNOR
serve you CARE

Index

Probes	2
Suction tubes	2
Scissors, delicate	2
Scissors, standard	3
Scissors, TC	4,5
Scalpel handles	6
Dissecting forceps, standard	7
Dissecting forceps, TC	7
Dressing and sponge holding forceps	8
Hemostatic forceps	8-11
Dissecting & ligature forceps	12
Towel forceps	12
Needle holders, standard	13
Needle holders, TC	13,14
Retractors, Hand	15
Retractors, self retaining	16
Sterilization	17,18

Inhaltsverzeichnis

Sonden	2
Saugkanülen	2
Feine scheren	2
Standard scheren	3
TC-scheren	4,5
Skalpellgriffe	6
Anatomische pinzetten	7
TC-Pinzetten	7
Tupfer-und schwammzangen	8
Arterienklemmen	8-11
Präparier & ligaturklemmen	12
Tuchklemmen	12
Standard Nadelhalter	13
TC-Nadelhalter	13,14
Wundhaken	15
Wundspreizer, selbsthaltend	16
Sterilisation	17,18

Page

Indice

Sondas	2
Cánulas de aspiración	2
Tijeras finas	2
Tijeras standard	3
Tijeras-TC	4,5
Mangos de bisturios	6
Pinzas de disección	7
Pinzas-TC	7
Pinzas para tapones y esponjas	8
Pinzas hemostáticas	8-11
Pinzas para preparaciones y ligaduras	12
Pinzas para compresas y de camp	12
Porta agujas, standard	13
Porta agujas-TC	13,14
Separadores	15
Separadores con retenida automática	16
Esterilizacion	17,18

Sommaire

Sondes	2
Canules à aspiration	2
Ciseaux fins	2
Ciseaux standard	3
Ciseaux-TC	4,5
Manches pour bistouris	6
Pinces à disséquer	7
Pinces-TC	7
Pinces à tampons et éponges	8
Pinces hémostatique	8-11
Pince à dissection et à ligatures	12
Pinces à compresses et à champs	12
Porte-aiguilles standard	13
Porte-aiguilles-TC	13,14
Ecarteurs	15
Ecarteurs autostatiques	16
Sterilisation	17,18

Página

Index

Plaster of paris	20,21
Mallets	22-24
Bone files, rasps	25
Elevators	26-30
Raspatories	28-30
Bone levers	31-33
Bone cutting forceps	34-36
Bone holding forceps	37-43
Amputation & resection saws	44
Wire forceps	45-47
Chisels, gouges & osteotomes	48-54
Bone curettes	55-59
Bone rongeurs	60-67
Hand bone drills	68
Finger ring saws	68
Nail instruments	68

Inhaltsverzeichnis

Gips / verband	20,21
Hämmer	22-24
Knochenfeilen, raspeln	25
Elevatorien	26-30
Raspatorien	28-30
Knochenhebel	31-33
Knochensplitterzangen	34-36
Knochenhalte-zangen	37-43
Amputations & resektionssägen	44
Drahtzangen	45-47
Flachmeißel, hohlmeißel & osteotome	48-54
Scharfe löffel	55-59
Hohlmeißelzangen	60-67
Handbohrapparate	68
Fingerringssägen	68
Nagelzange	68

Page

Indice

Vendajes enyesados	20,21
Martillos y mazos	22-24
Limas para huesos, Escofinas	25
Elevadores	26-30
Periostótomos	28-30
Elevadores para huesos	31-33
Pinzas cortantes para huesos	34-36
Pinzas para huesos	37-43
Sierras para amputación y resección	44
Pinzas para hilos	45-47
Cinceles, Gubias y Osteótomos	48-54
Cucharillas cortantes	55-59
Pinzas gubias	60-67
Perforadores de mano para huesos	68
Sierras para abrir anillos	68
Pinza para uñas	68

Sommaire

Bandage plâtrès	20,21
Maillets	22-24
Limes à os, Râpes à os	25
Elévateurs	26-30
Rugines	28-30
Levier à os	31-33
Pinces coupantes	34-36
Daviers	37-43
Scies à amputation et résection	44
Pinces à fil	45-47
Ciseaux-Burins, Gouges et Ostéotomes	48-54
Curettes tranchantes	55-59
Pinces gouges	60-67
Perforateur à main	68
Scies pour bagues et	68
Pince à ongle	68

Página



General Surgery

Probes

Sonden
Sondas
Sondes

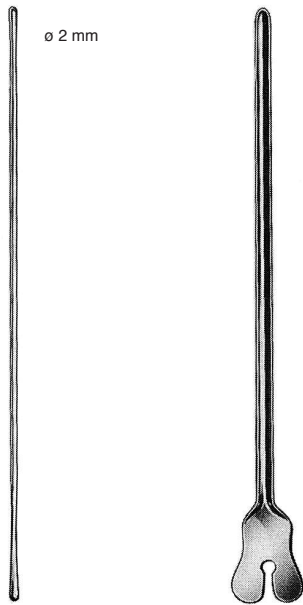

PB. 02.13 13 cm
PB. 02.14 14.5 cm
PB. 02.16 16 cm
PB. 02.18 18 cm

PB. 07.13 13 cm
PB. 07.14 14.5 cm
PB. 07.18 18 cm

Suction tubes

Saugkanülen
Cánulas de aspiración
Canules à aspiration

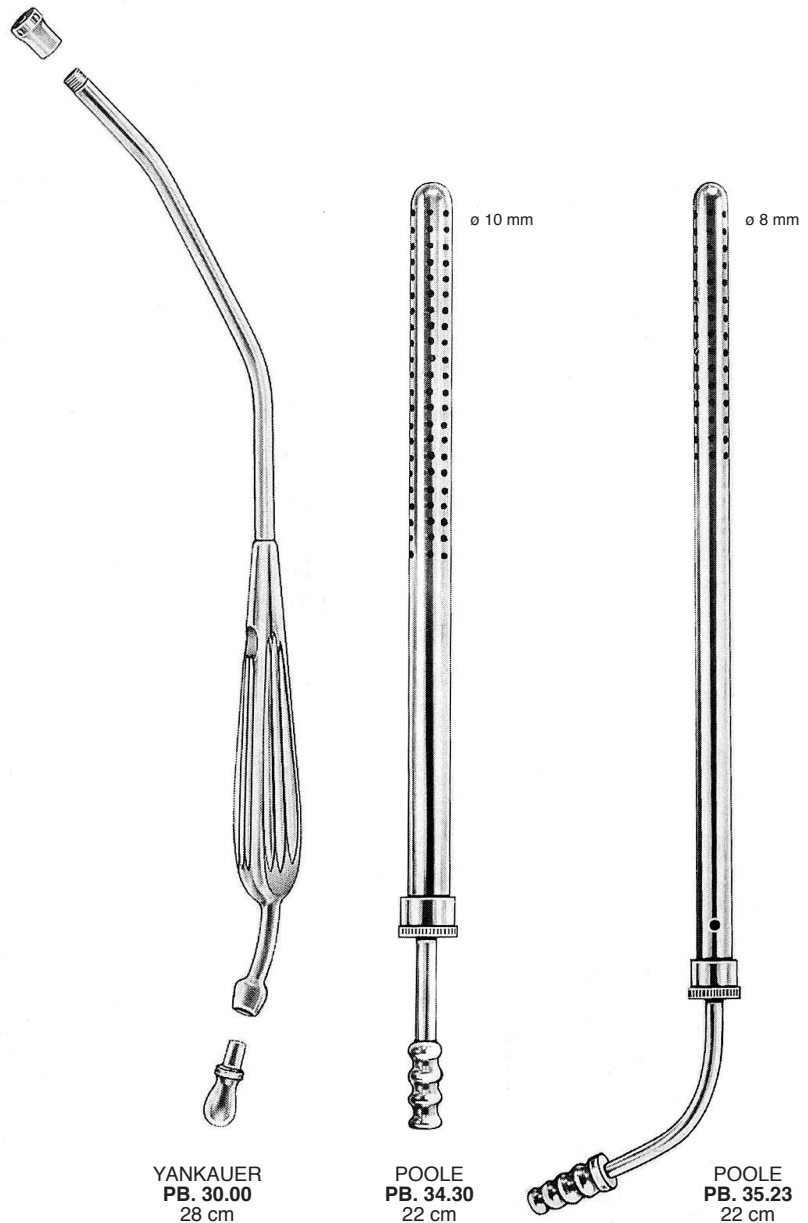

YANKAUER
PB. 30.00
28 cm

POOLE
PB. 34.30
22 cm

POOLE
PB. 35.23
22 cm

Delicate scissors

Feine Scheren
Tijeras finas
Ciseaux fins

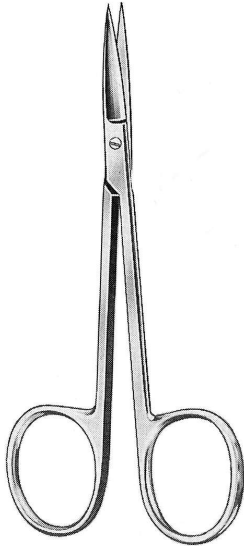

IRIS

<i>Straight</i>		<i>Curved</i>
PC. 01.09	9 cm	PC. 02.09
PC. 01.10	10.5 cm	PC. 02.10
PC. 01.11	11.5 cm	PC. 02.11

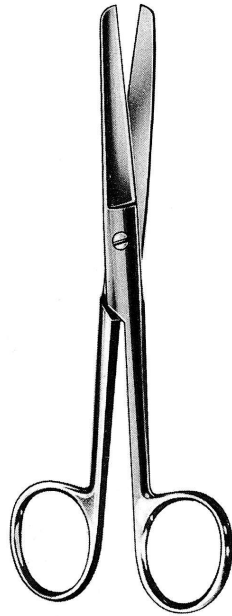

Blunt/Blunt

<i>Straight</i>		<i>Curved</i>
PC. 14.11	11.5 cm	PC. 18.11
PC. 14.13	13 cm	PC. 18.13
PC. 14.14	14.5 cm	PC. 18.14
PC. 14.16	16.5 cm	PC. 18.16

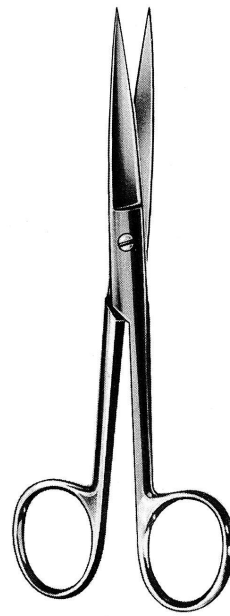

Sharp/Sharp

<i>Straight</i>		<i>Curved</i>
PC. 15.11	11.5 cm	PC. 19.11
PC. 15.13	13 cm	PC. 19.13
PC. 15.14	14.5 cm	PC. 19.14
PC. 15.16	16.5 cm	PC. 19.16

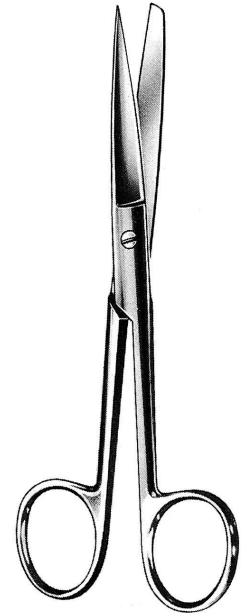

Sharp/Blunt

<i>Straight</i>		<i>Curved</i>
PC. 16.11	11.5 cm	PC. 17.11
PC. 16.13	13 cm	PC. 17.13
PC. 16.14	14.5 cm	PC. 17.14
PC. 16.16	16.5 cm	PC. 17.16

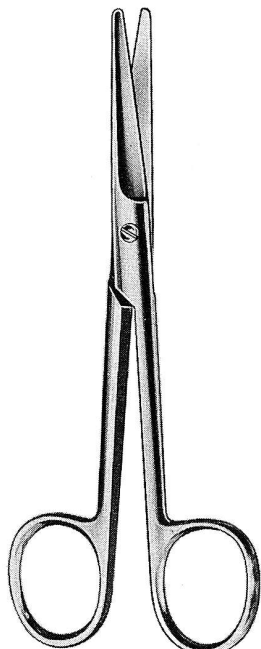

MAYO

<i>Straight</i>		<i>Curved</i>
PC. 24.14	14 cm	PC. 25.14
PC. 24.15	15.5 cm	PC. 25.15
PC. 24.17	17 cm	PC. 25.17
PC. 24.23	23 cm	PC. 25.23

MAYO-HARRINGTON

<i>Straight</i>		<i>Curved</i>
PC. 24.60	20 cm	PC. 25.60
PC. 24.63	23 cm	PC. 25.63

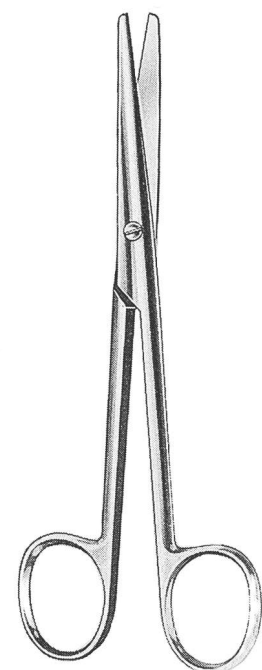
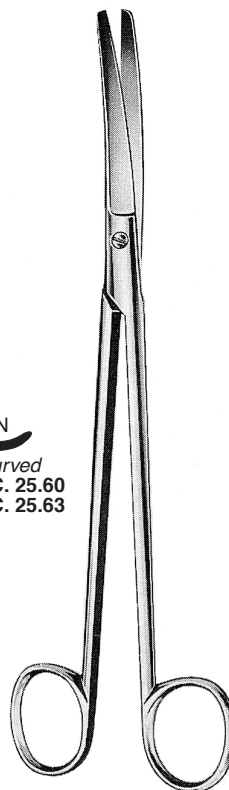

MAYO-STILLE

<i>Straight</i>		<i>Curved</i>
PC. 28.15	15 cm	PC. 30.15
PC. 28.17	17 cm	PC. 30.17
PC. 28.23	23 cm	PC. 30.23

Operating and dissecting scissors, PROLONG TC®

Operations - und Präparierscheren, **PROLONG TC®**

Tijeras para cirugía y preparaciones, **PROLONG TC®**

Ciseaux à chirurgie et dissection, **PROLONG TC®**

Scissors with tungsten carbide cutting edges

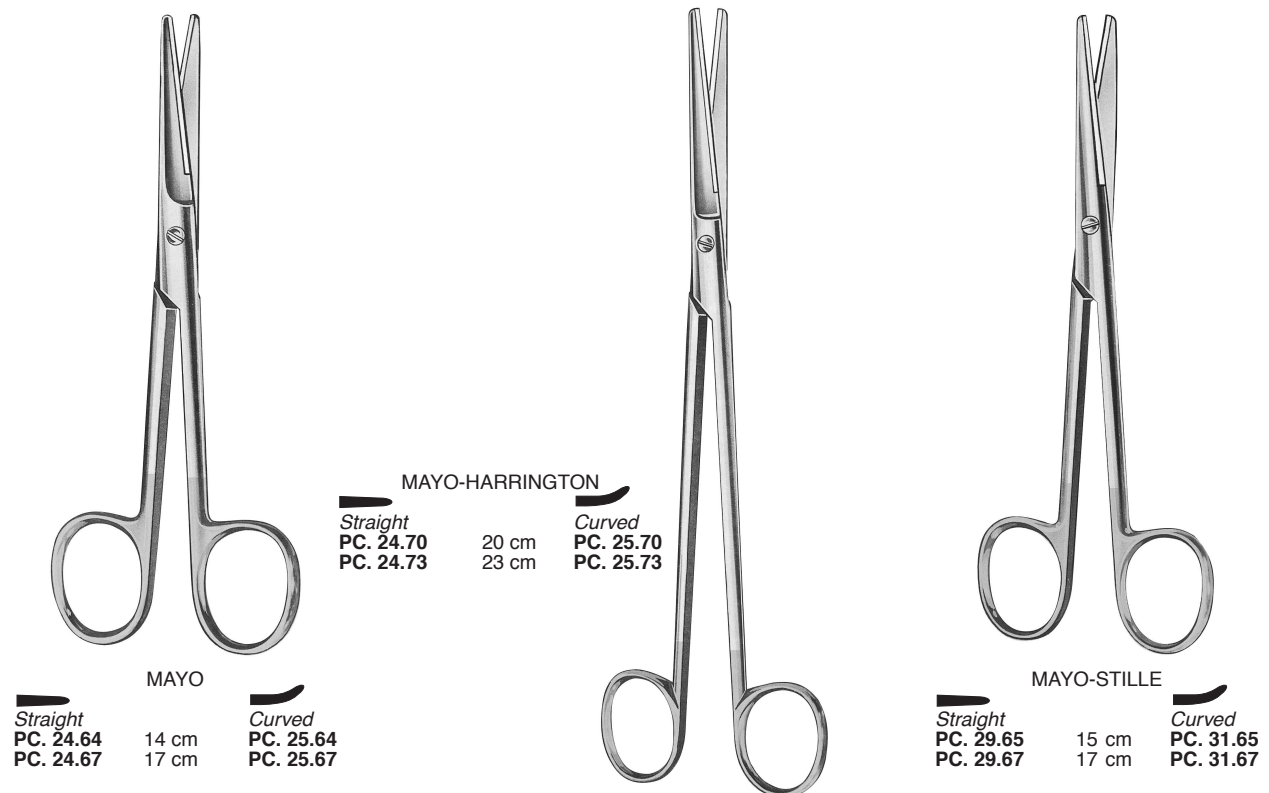

Dissecting scissors, PROLONG TC®
 Präparierscheren, PROLONG TC®
 Tijeras para preparaciones, PROLONG TC®
 Ciseaux à dissection, PROLONG TC®

Scissors with tungsten carbide cutting edges

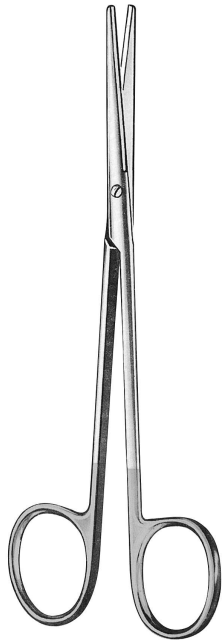

METZENBAUM (LAHEY)
 Straight PC. 36.64 14 cm Curved PC. 37.64



METZENBAUM
 Straight PC. 38.68 18 cm Curved PC. 39.68
 PC. 38.70 20 cm PC. 39.70



NELSON (METZENBAUM)
 Straight PC. 40.73 23 cm Curved PC. 41.73
 PC. 40.76 26 cm PC. 41.76
 PC. 40.80 30 cm PC. 41.80

Scalpel handles

Skalpelli

Mangos de bisturios

Manches pour bistouris

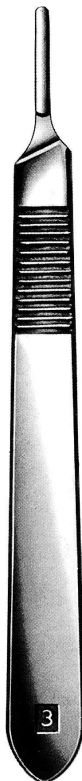

NO. 3
PE. 04.03
12 cm

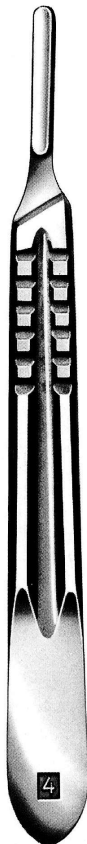

NO. 4
PE. 09.04
13 cm



NO. 7
PE. 05.07
16 cm

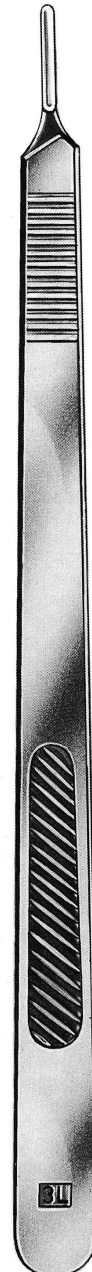

NO. 3 L
PE. 07.13
21 cm

Dissecting forceps
 Anatomische Pinzetten
 Pinzas de disección
 Pincès à disséquer

Dissecting forceps, PROLONG TC®
 Anatomische Pinzetten, PROLONG TC®
 Pinzas de disección, PROLONG TC®
 Pincès à disséquer, PROLONG TC®

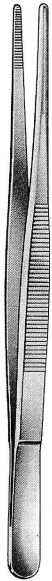

STANDARD
 PF. 01.10 10.5 cm
 PF. 01.11 11.5 cm
 PF. 01.13 13 cm
 PF. 01.14 14.5 cm
 PF. 01.16 16 cm
 PF. 01.18 18 cm
 PF. 01.20 20 cm
 PF. 01.25 25 cm
 PF. 01.30 30 cm

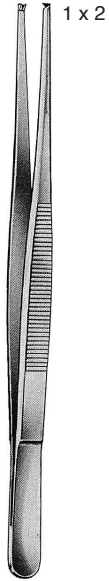

STANDARD 1 x 2
 PF. 05.10 10.5 cm
 PF. 05.11 11.5 cm
 PF. 05.13 13 cm
 PF. 05.14 14.5 cm
 PF. 05.16 16 cm
 PF. 05.18 18 cm
 PF. 05.20 20 cm
 PF. 05.25 25 cm
 PF. 05.30 30 cm

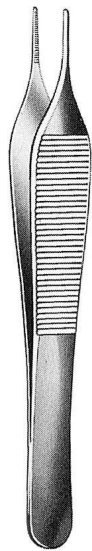

ADSON
 PF. 15.12 12 cm
 PF. 15.15 15 cm

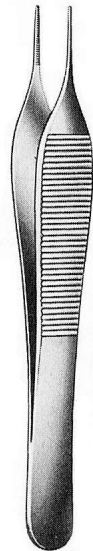

MICRO-ADSON
 PF. 17.12 12 cm
 PF. 18.15 15 cm

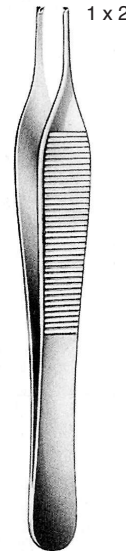

ADSON
 PF. 16.12 12 cm
 PF. 16.15 15 cm

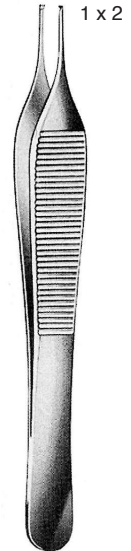

MICRO-ADSON
 PF. 19.12 12 cm
 PF. 20.15 15 cm

Forceps with tungsten carbide tips



**ATRAUMATIC
 PROLONG TC®**
 PF. 01.64 14.5 cm
 PF. 01.68 18 cm
 PF. 01.70 20 cm
 PF. 01.75 25 cm

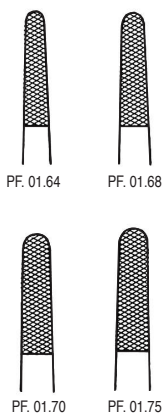

POTTS-SMITH
 PF. 39.65 15 cm
 PF. 39.68 18 cm
 PF. 39.70 20 cm
 PF. 39.73 23 cm
 PF. 39.75 25 cm

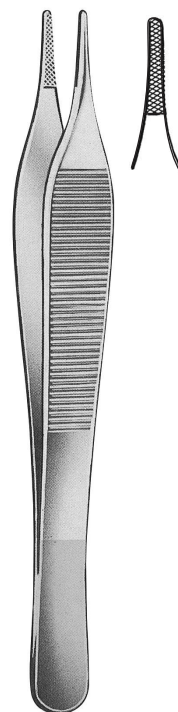
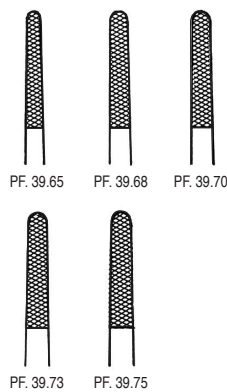

ADSON
 PF. 15.62 12 cm

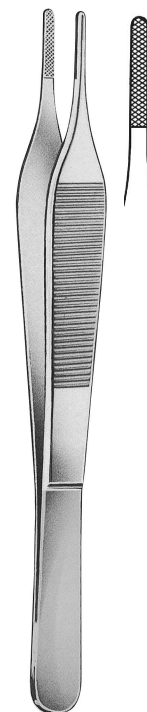

ADSON
 PF. 15.65 15 cm

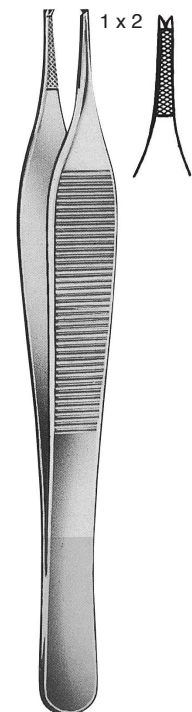

ADSON
 PF. 16.62 12 cm
 PF. 16.65 15 cm

Dressing & sponge holding forceps

Tupfer- und Schwammzangen
 Pinzas para tapones y esponjas
 Pincas à tampons et éponges

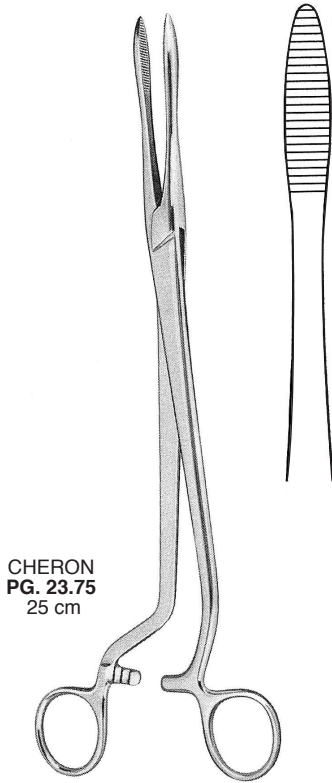

CHERON
 PG. 23.75
 25 cm

Hemostatic forceps

Arterienklemmen
 Pinzas hemostáticas
 Pincas hémostatique

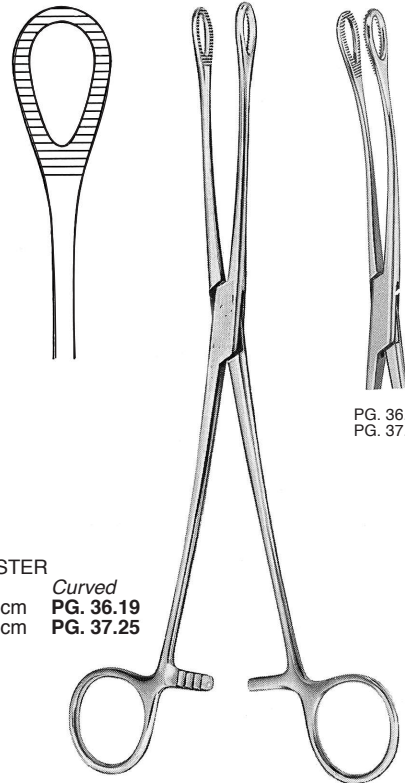

FOERSTER
Straight PG. 36.18 18 cm
 PG. 37.24 24 cm
Curved PG. 36.19
 PG. 37.25

PG. 36.19
 PG. 37.25

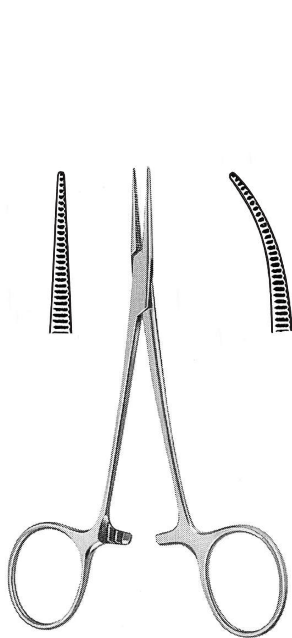

HALSTED-MOSQUITO
Straight PH. 10.12 12.5 cm
Curved PH. 11.12

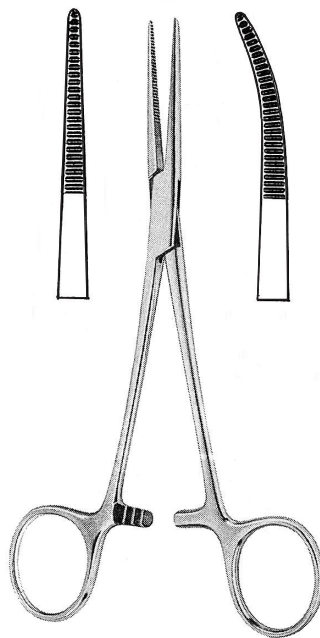

RANKIN-KELLY
Straight PH. 42.14 14 cm
 PH. 44.16 16 cm
Curved PH. 43.14
 PH. 45.16

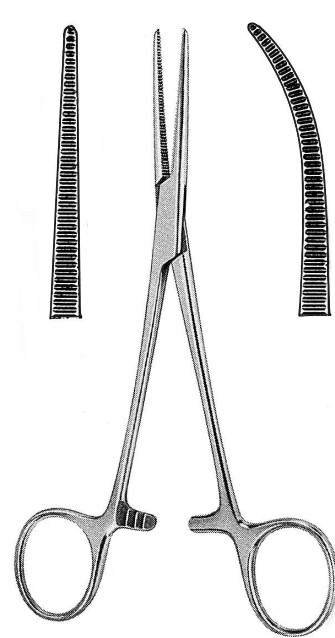

RANKIN-CRILE
Straight PH. 46.14 14 cm
 PH. 48.16 16 cm
Curved PH. 47.14
 PH. 49.16

Hemostatic forceps

Arterienklemmen

Pinzas hemostáticas

Pinces hémostatique



PH. 60.16



PH. 60.18



PH. 60.20



PH. 60.22
PH. 60.24



PH. 60.26



PH. 56.16



PH. 56.18



PH. 56.20



PH. 56.22
PH. 56.24

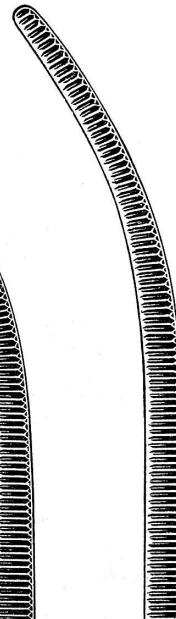

PH. 56.26



ROCHESTER-PEAN

<i>Straight</i>		<i>Curved</i>
PH. 60.16	16 cm	PH. 56.16
PH. 60.18	18 cm	PH. 56.18
PH. 60.20	20 cm	PH. 56.20
PH. 60.22	22 cm	PH. 56.22
PH. 60.24	24 cm	PH. 56.24
PH. 60.26	26 cm	PH. 56.26

Hemostatic forceps

Arterienklemmen

Pinzas hemostáticas

Pinces hémostatique



PH. 62.16



PH. 62.18



PH. 62.20



PH. 62.22
PH. 62.24



PH. 62.26



PH. 63.16



PH. 63.18

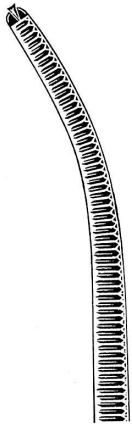

PH. 63.20



PH. 63.22
PH. 63.24

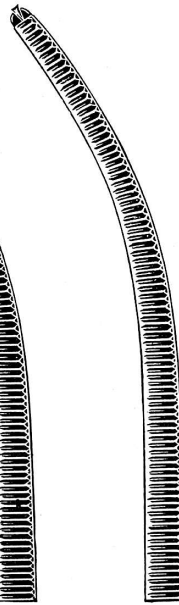

PH. 63.26



ROCHESTER-UCHSNER

Straight

PH. 62.16

PH. 62.18

PH. 62.20

PH. 62.22

PH. 62.24

PH. 62.26

Curved

PH. 63.16

PH. 63.18

PH. 63.20

PH. 63.22

PH. 63.24

PH. 63.26

Hemostatic forceps

Arterienklemmen

Pinzas hemostáticas

Pinces hémostatique

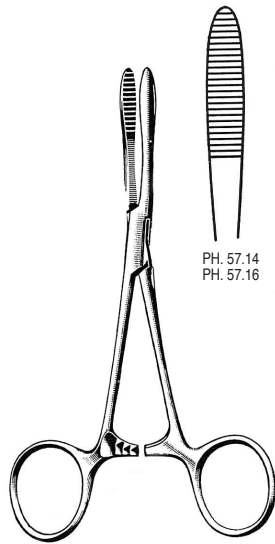

PH. 57.14
PH. 57.16

PEAN
PH. 57.14 14 cm
PH. 57.16 16 cm

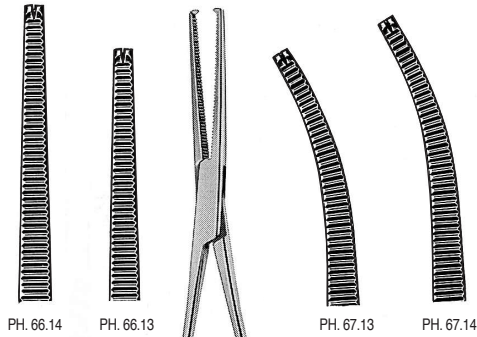

PH. 66.14

PH. 66.13

PH. 67.13

PH. 67.14

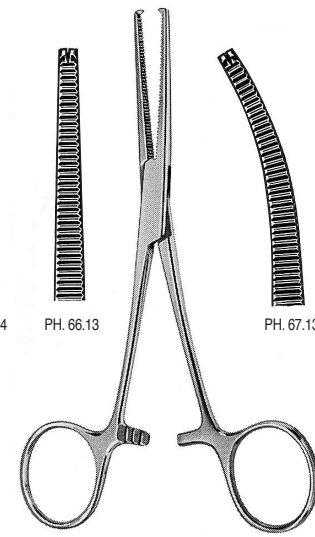

KOCHER

Straight
PH. 66.13 13 cm
PH. 66.14 14 cm

13 cm
14 cm

Curved
PH. 67.13 13 cm
PH. 67.14 14 cm

13 cm
14 cm

PH. 73.23
PH. 73.24

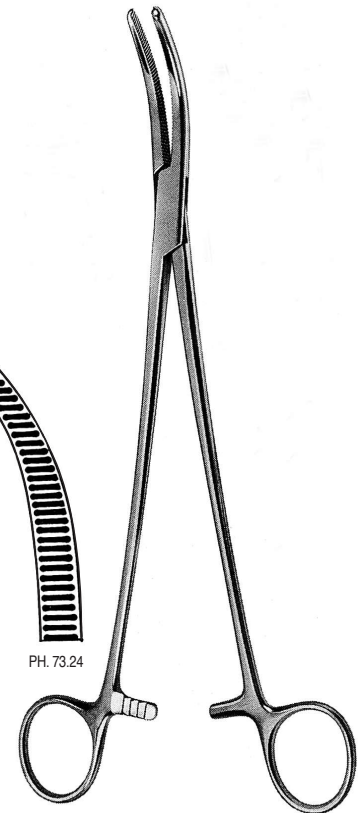

MOYNIHAN
PH. 73.23 23 cm
PH. 73.24 24 cm

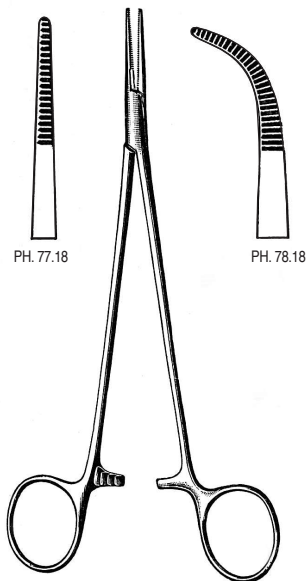

PH. 77.18

PH. 78.18

HALSTED (ADSON)
Straight PH. 77.18 18 cm
Curved PH. 78.18

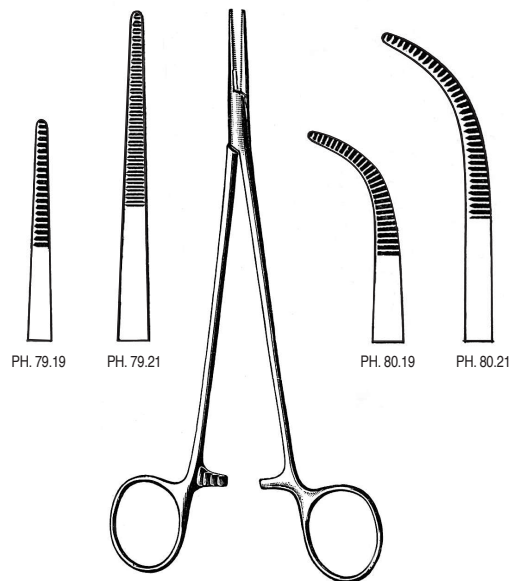

PH. 79.19

PH. 79.21

PH. 80.19

PH. 80.21

ADSON

Straight
PH. 79.19 18.5 cm
PH. 79.21 18.5 cm

18.5 cm
18.5 cm

Curved
PH. 80.19 18.5 cm
PH. 80.21 18.5 cm

Dissecting & ligature forceps

Präparier- & Ligaturklemmen

Pinzas para preparaciones y ligaduras

Pince à dissection et à ligatures

Towel forceps

Tuchklemmen

Pinzas para compresas y de campo

Pinces à compresses et à champs

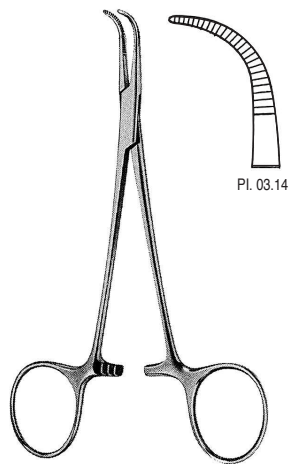

MIXTER-BABY
Pl. 03.14 14 cm

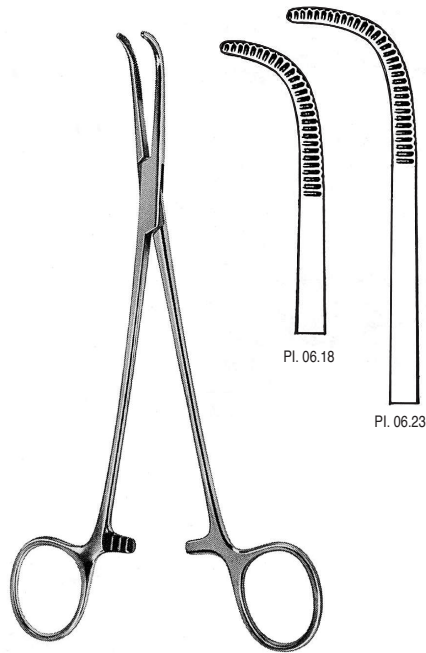

MIXTER
Pl. 06.18 18 cm
Pl. 06.23 23 cm



GEMINI
Pl. 08.14 14 cm
Pl. 08.18 18 cm
Pl. 08.20 20 cm

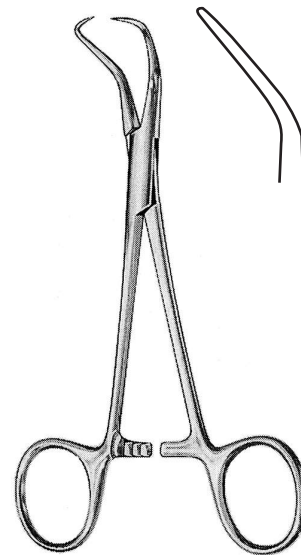

BACKHAUS
Pl. 25.08 8 cm
Pl. 25.10 11 cm
Pl. 26.13 13 cm
Pl. 26.15 15 cm

Needle holders

Nadelhalter

Porta agujas

Porte aiguilles

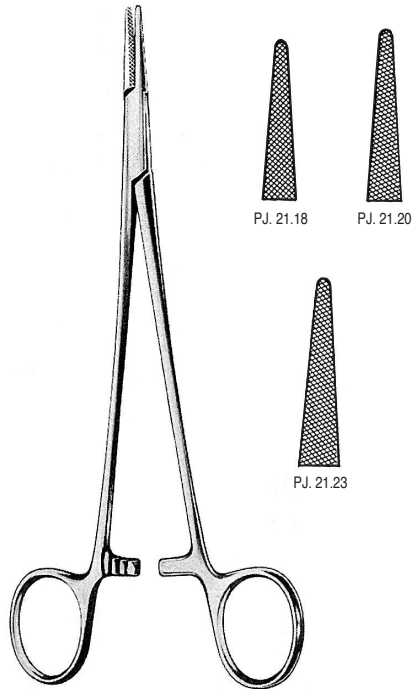

CRILE-WOOD
PJ. 21.18 18 cm
PJ. 21.20 20 cm
PJ. 21.23 23 cm

Needle holders, PROLONG TC®

Nadelhalter, PROLONG TC®

Porta agujas, PROLONG TC®

Porte aiguilles, PROLONG TC®

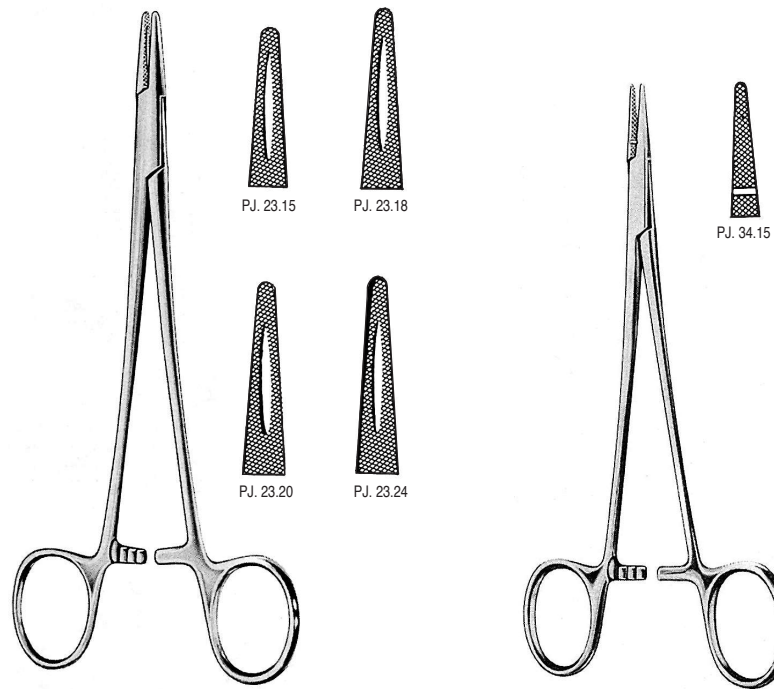

MAYO-HEGAR
PJ. 23.15 15 cm
PJ. 23.18 18 cm
PJ. 23.20 20 cm
PJ. 23.24 24 cm

CRILE-WOOD
PJ. 34.15 15 cm

Needle holders with tungsten carbide jaws

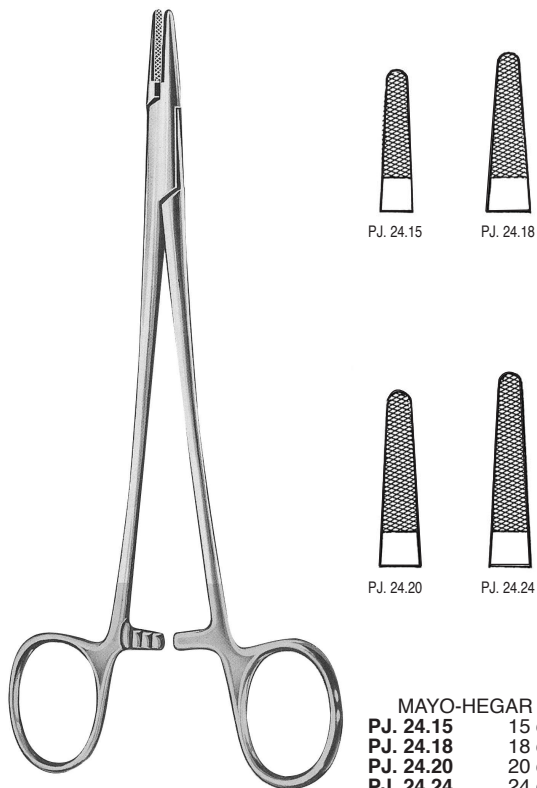

MAYO-HEGAR
PJ. 24.15 15 cm
PJ. 24.18 18 cm
PJ. 24.20 20 cm
PJ. 24.24 24 cm

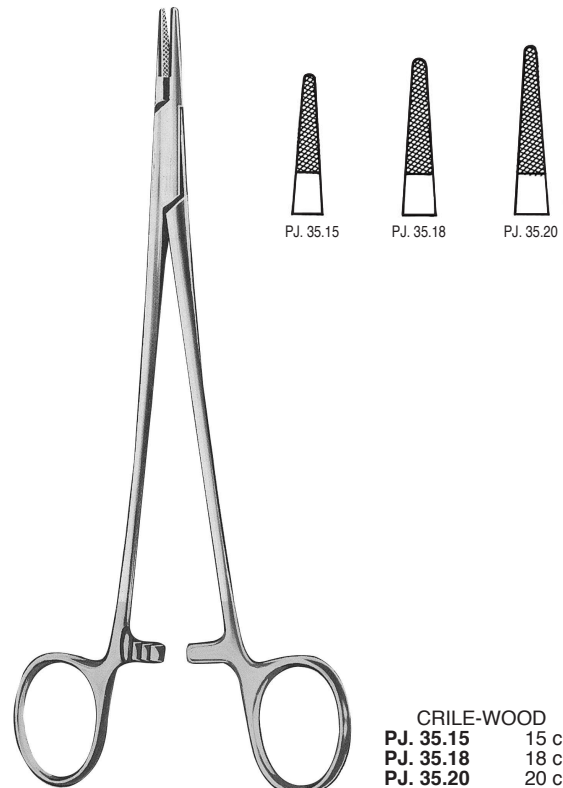

CRILE-WOOD
PJ. 35.15 15 cm
PJ. 35.18 18 cm
PJ. 35.20 20 cm

Needle holders, PROLONG TC®

Nadelhalter, **PROLONG TC®**

Porta agujas, **PROLONG TC®**

Porte aiguilles, **PROLONG TC®**

Needle holders with tungsten carbide jaws

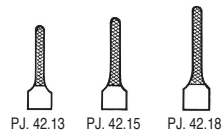

PJ. 42.13 PJ. 42.15 PJ. 42.18

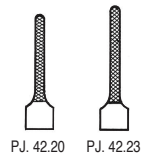

PJ. 42.20 PJ. 42.23



**RYDER
(FRENCH EYE)**

PJ. 42.13	13 cm
PJ. 42.15	15 cm
PJ. 42.18	18 cm
PJ. 42.20	20 cm
PJ. 42.23	23 cm

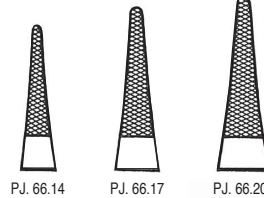

PJ. 66.14 PJ. 66.17 PJ. 66.20



MATHIEU-KOCHER

PJ. 66.14	14 cm
PJ. 66.17	17 cm
PJ. 66.20	20 cm

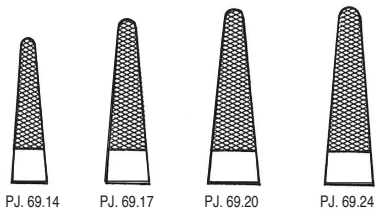

PJ. 69.14 PJ. 69.17 PJ. 69.20 PJ. 69.24



MATHIEU

PJ. 69.14	14 cm
PJ. 69.17	17 cm
PJ. 69.20	20 cm
PJ. 69.24	24 cm

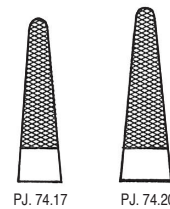

PJ. 74.17 PJ. 74.20



MATHIEU

PJ. 74.17	17 cm
PJ. 74.20	20 cm

Retractors

Wundhaken

Separadores

Ecarteurs

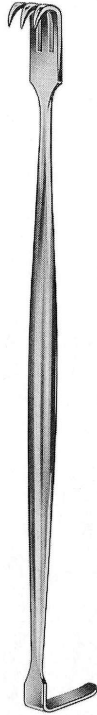

SENN-MUELLER
PY. 01.16 16 cm Sharp
PY. 02.16 16 cm Blunt



PY. 02.16
 Blunt

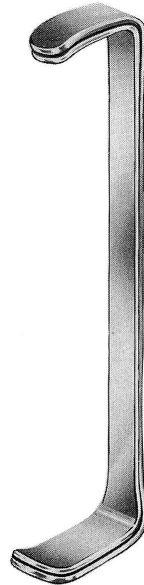

FARABEUf-BABY
PY. 46.12 12 cm

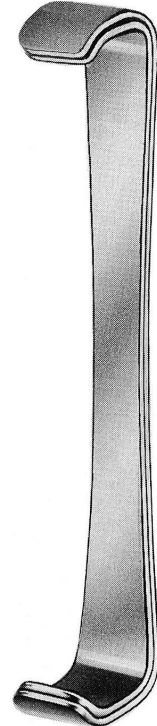

FARABEUf
PY. 47.15 15 cm



VOLKMAN
 22 cm



PY. 59.22 Sharp
PY. 60.22 Blunt



PY. 59.23 Sharp
PY. 60.23 Blunt



PY. 59.24 Sharp
PY. 60.24 Blunt



LANGENBECK
PY. 71.10 21 cm
PY. 71.13 21 cm
PY. 71.16 21 cm



PY. 71.10
PY. 72.10
 10 x 40 mm



PY. 71.13
PY. 72.13
 13 x 42 mm



PY. 71.16
PY. 72.16
 16 x 42 mm

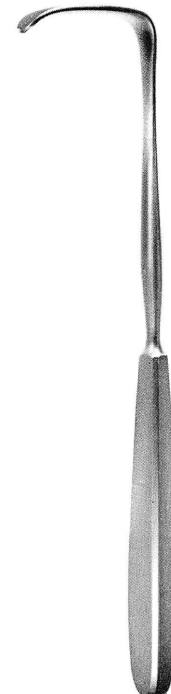

LANGENBECK
PY. 72.10 21 cm
PY. 72.13 21 cm
PY. 72.16 21 cm

Self-retaining retractors

Wundspreizer, selbsthaltend

Separadores con retenida automática

Ecarteurs autostatiques

Laminectomy retractors

Laminektomie-Wundspreizer

Separadores para laminectomía

Ecarteurs pour laminectomie

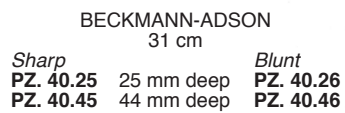
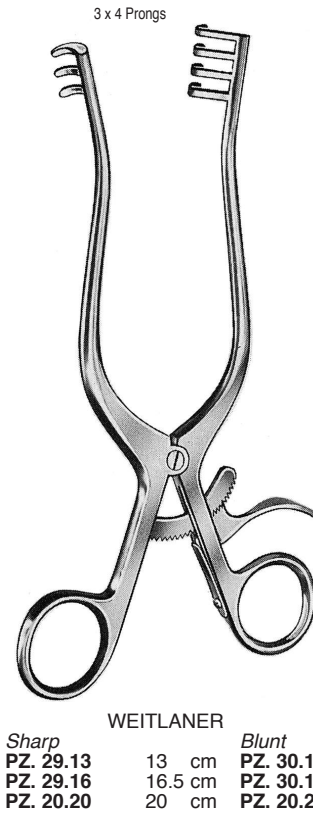
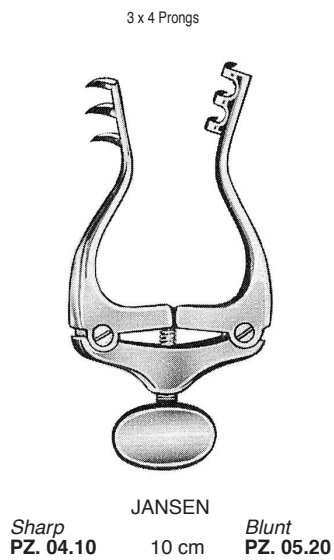

Sterilization
 Sterilisation
 Esterilizacion
 Sterilisation

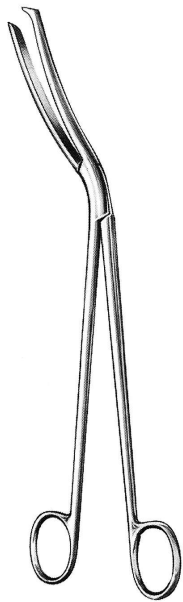

CHEATLE
 PR. 03.27 27 cm

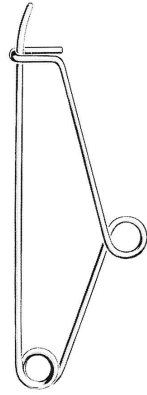

MAYO
 PR. 10.14 14 cm

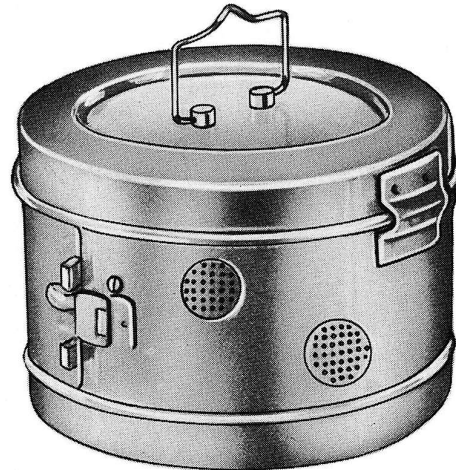

SCHIMMELBUSCH

	ø	h
PR. 25.14	14	14 cm
PR. 25.16	16	15 cm
PR. 25.19	19	16 cm
PR. 25.20	19	19 cm
PR. 25.24	24	12 cm
PR. 25.25	24	16 cm
PR. 25.27	24	24 cm
PR. 25.29	29	16 cm
PR. 25.30	29	24 cm
PR. 25.34	34	16 cm
PR. 25.35	34	24 cm
PR. 25.39	39	14 cm
PR. 25.40	39	19 cm
PR. 25.41	39	29 cm



KONRICH

	ø	h
PR. 26.14	14	14 cm
PR. 26.16	16	15 cm
PR. 26.19	19	16 cm
PR. 26.20	19	19 cm
PR. 26.24	24	12 cm
PR. 26.25	24	16 cm
PR. 26.27	24	24 cm
PR. 26.29	29	16 cm
PR. 26.30	29	24 cm
PR. 26.34	34	16 cm
PR. 26.35	34	24 cm
PR. 26.39	39	14 cm
PR. 26.40	39	19 cm
PR. 26.41	39	29 cm

Inserts for KONRICH

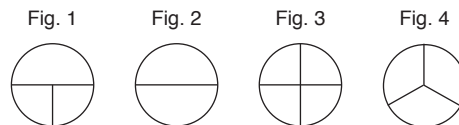

				ø	h
PR. 27.14	PR. 28.14	PR. 29.14	PR. 30.14	14	14 cm
PR. 27.16	PR. 28.16	PR. 29.16	PR. 30.16	16	15 cm
PR. 27.19	PR. 28.19	PR. 29.19	PR. 30.19	19	16 cm
PR. 27.20	PR. 28.20	PR. 29.20	PR. 30.20	19	19 cm
PR. 27.24	PR. 28.24	PR. 29.24	PR. 30.24	24	12 cm
PR. 27.25	PR. 28.25	PR. 29.25	PR. 30.25	24	16 cm
PR. 27.27	PR. 28.27	PR. 29.27	PR. 30.27	24	24 cm
PR. 27.29	PR. 28.29	PR. 29.29	PR. 30.29	29	16 cm
PR. 27.30	PR. 28.30	PR. 29.30	PR. 30.30	29	24 cm
PR. 27.34	PR. 28.34	PR. 29.34	PR. 30.34	34	16 cm
PR. 27.35	PR. 28.35	PR. 29.35	PR. 30.35	34	24 cm
PR. 27.39	PR. 28.39	PR. 29.39	PR. 30.39	39	14 cm
PR. 27.40	PR. 28.40	PR. 29.40	PR. 30.40	39	19 cm
PR. 27.41	PR. 28.41	PR. 29.41	PR. 30.41	39	29 cm

Sterilization
Sterilisation
Esterilizacion
Sterilisation



PAF. 04.15	150 x 100 x 25 mm
PAF. 04.20	200 x 150 x 40 mm
PAF. 04.25	250 x 200 x 50 mm
PAF. 04.30	300 x 250 x 50 mm
PAF. 04.35	350 x 300 x 50 mm
PAF. 04.40	400 x 300 x 50 mm
PAF. 04.45	450 x 350 x 50 mm

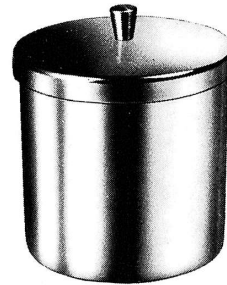

PF. 08.85	85 x 85 mm
PF. 08.90	100 x 100 mm
PF. 08.92	120 x 120 mm
PF. 08.95	150 x 150 mm

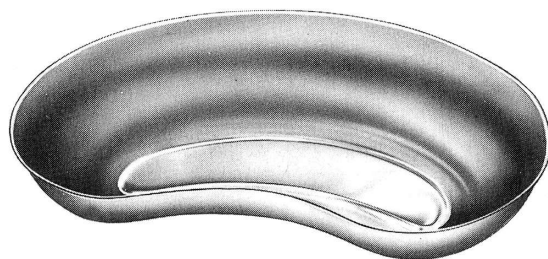

PAF. 10.17	170 x 100 x 35 mm
PAF. 10.25	250 x 140 x 40 mm
PAF. 10.27	275 x 150 x 45 mm
PAF. 10.30	305 x 140 x 50 mm



PAF. 12.07	165 x 60 mm
PAF. 12.10	175 x 70 mm
PAF. 12.25	225 x 90 mm
PAF. 12.45	275 x 115 mm
PAF. 12.60	290 x 125 mm
PAF. 12.85	345 x 125 mm
PAF. 12.91	380 x 125 mm
PAF. 12.94	405 x 150 mm

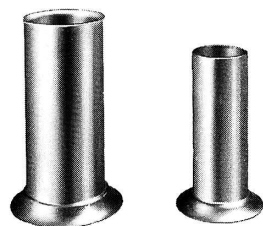

PAF. 15.30	30 x 90 mm
PAF. 15.50	50 x 100 mm
PAF. 15.51	50 x 120 mm
PAF. 15.56	60 x 130 mm
PAF. 15.76	75 x 130 mm
PAF. 15.77	75 x 175 mm
PAF. 15.80	100 x 150 mm

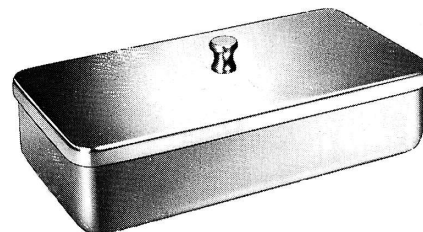

PAF. 21.16	165 x 90 x 35 mm
PAF. 21.21	200 x 100 x 50 mm
PAF. 21.23	230 x 130 x 50 mm
PAF. 21.26	260 x 150 x 50 mm
PAF. 21.30	305 x 205 x 50 mm



Orthopedics

Bandage scissors

Verbandscheren
Tijeras para vendajes
Ciseaux pour pansements

Cloth & plaster-of-paris shears

Kleiderstoff & Gippscheren
Tijeras para vestidos y Cizallas para yesos
Cisailles pour pansements et pour appareils plâtres

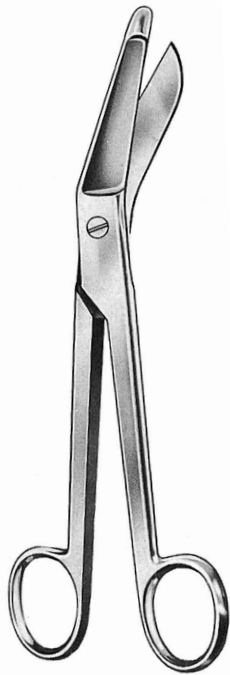

ESMARCH
PL. 04.20 20 cm
PL. 04.22 22 cm

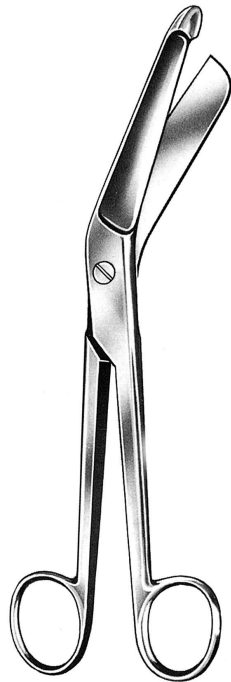

BERGMANN
PL. 05.23 23 cm



BRUNS
PL. 06.23 Serrated
PL. 07.24 Plain 23.5 cm

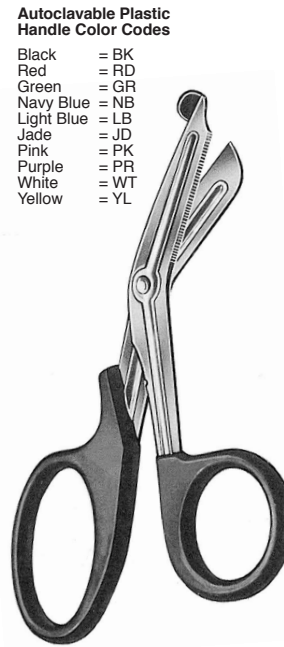

UNIVERSAL
PL. 08.14 14 cm
PL. 08.18 18 cm

Autoclavable Plastic Handle Color Codes

Black	= BK
Red	= RD
Green	= GR
Navy Blue	= NB
Light Blue	= LB
Jade	= JD
Pink	= PK
Purple	= PR
White	= WT
Yellow	= YL

Scissors with tungsten carbide cutting edges



LISTER
PL. 12.09 9 cm
PL. 12.11 11 cm
PL. 12.14 14 cm
PL. 12.18 18 cm
PL. 12.20 20 cm

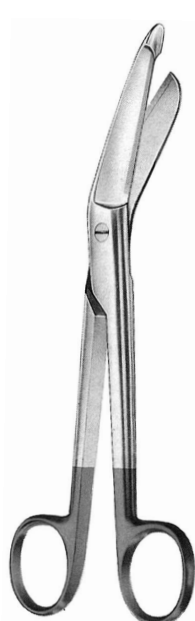

LISTER
PROLONG TC®
PL. 12.64 14 cm
PL. 12.68 18 cm

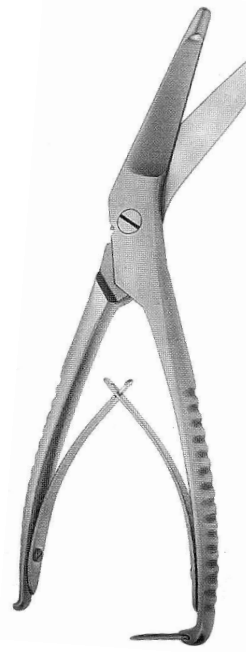

PL. 15.21 21 cm



SEUTIN
PL. 16.23 23 cm

Plaster cast spreaders, Plaster-of-Paris shears

Gipsspreizer, Gipsscheren

Pinzas y Cizallas para romper los vendajes enyesados

Pinces et cisailles écartantes pour appareils plâtrés

Plaster-of-Paris knives & saw

Gipsmesser, Gipssäge

Cuchillos, Sierre de mano

Couteaux, Scie à main

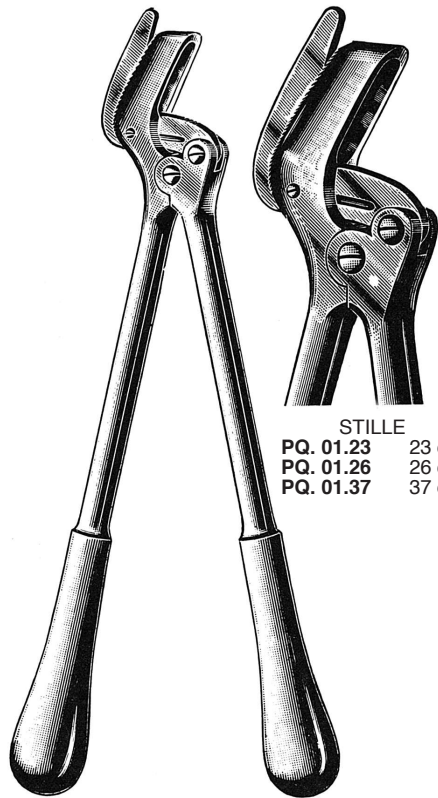

STILLE
PQ. 01.23 23 cm
PQ. 01.26 26 cm
PQ. 01.37 37 cm

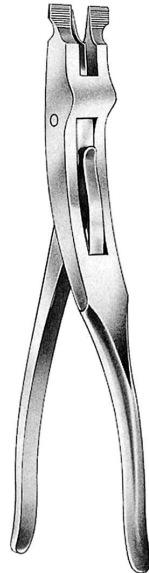

MOD. USA
PQ. 03.23 23 cm

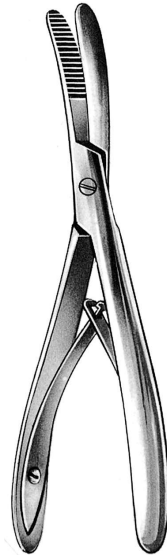

WOLFF
PQ. 04.18 18 cm
PQ. 04.24 24 cm



HENNIG
PQ. 05.27 27 cm

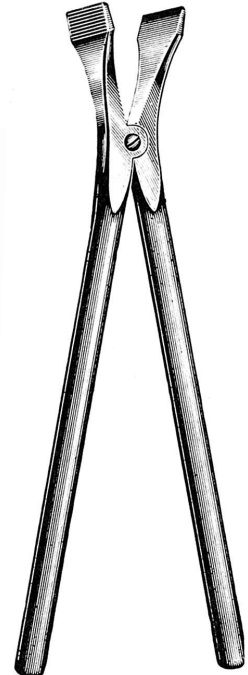

BEESON
PQ. 06.30 30 cm

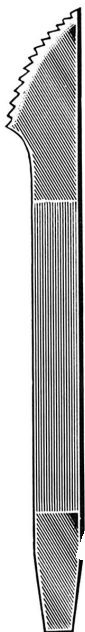

WIGMORE
PQ. 09.19 19 cm

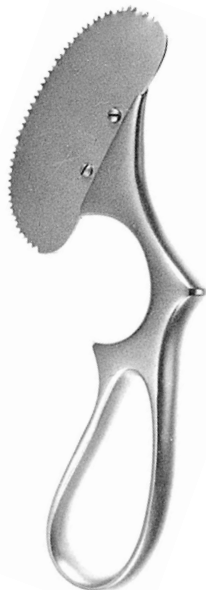

ENGEL
PQ. 10.15 15 cm



ESMARCH
PQ. 11.18 18 cm



HOPKINS
PQ. 12.20 20 cm



REINER
PQ. 13.19 18.5 cm

Mallets

Hämmer

Martillos y Mazos

Maillets

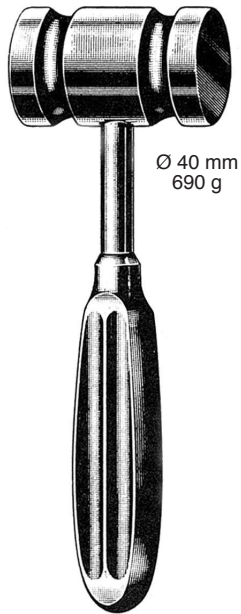

KIRK
PM. 02.20 19.5 cm

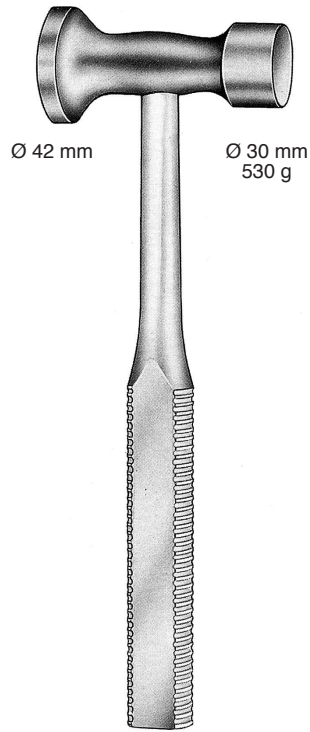

PM. 05.24 24 cm

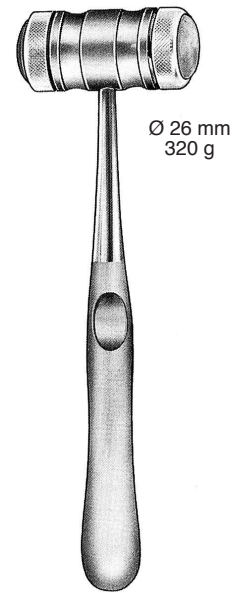

MEAD
PM. 06.19 17 cm

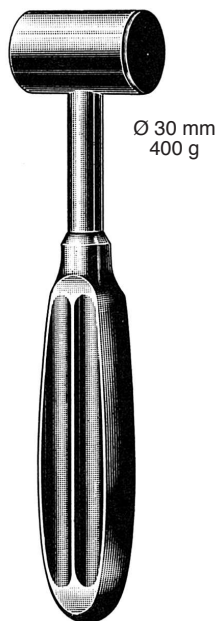

GERZOG
PM. 07.18 18 cm

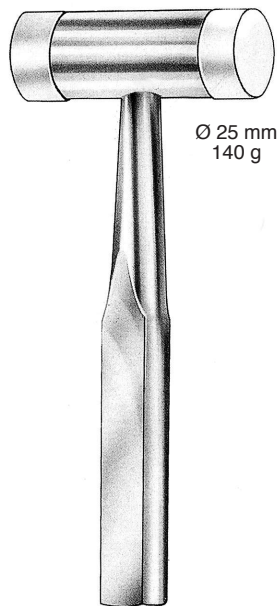

PM. 08.18 18 cm

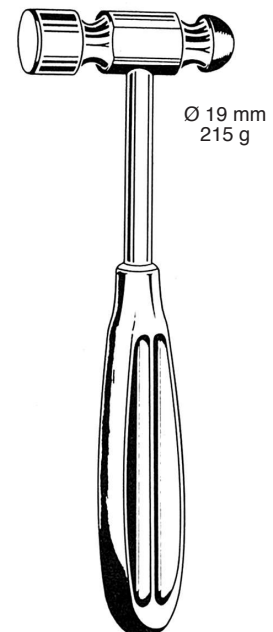

PM. 09.19 19 cm

Mallets

Hämmer

Martillos y Mazos

Maillets

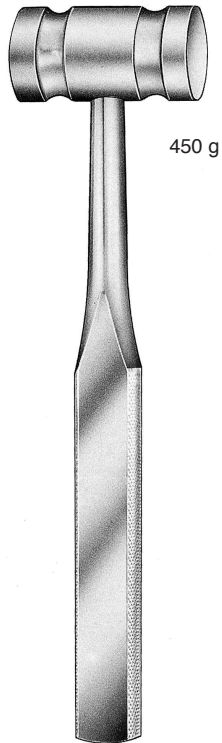

450 g

PM. 17.26 26.5 cm

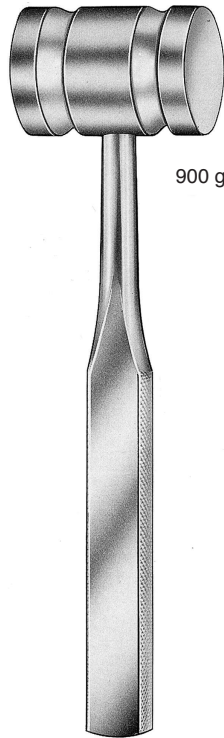

900 g

PM. 18.26 26.5 cm

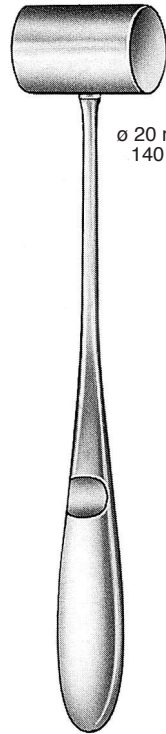

ø 20 mm
140 g

THIESS
PM. 20.16 16 cm

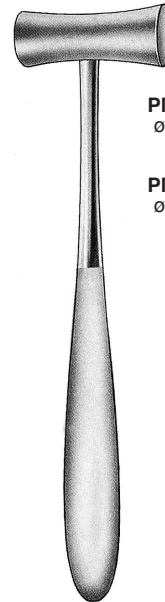

PM. 21.19
ø 19 mm
230 g

PM. 21.25
ø 25 mm
260 g

LUCAE
19 cm

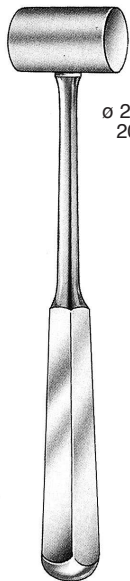

ø 22 mm
200 g

PARTSCH
PM. 22.18 18 cm

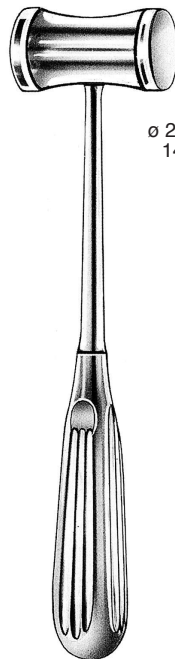

ø 27 mm
140 g

HAJEK
PM. 24.22 22 cm

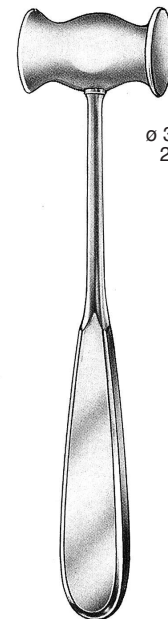

ø 30 mm
220 g

COLLIN
PM. 25.20 20 cm

Mallets

Hämmer

Martillos y Mazos

Maillets

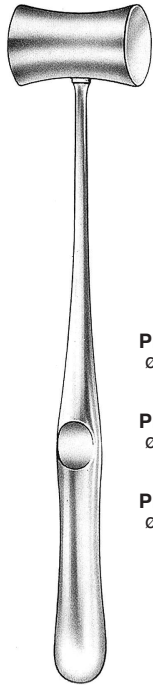

PM. 27.30
ø 26 mm
300 g

PM. 27.34
ø 28 mm
340 g

PM. 27.40
ø 30 mm
400 g

WILLIGER
24 cm



PM. 30.12
ø 25 mm
120 g

PM. 30.18
ø 30 mm
180 g

PM. 30.26
ø 35 mm
260 g

DOYEN
20 cm

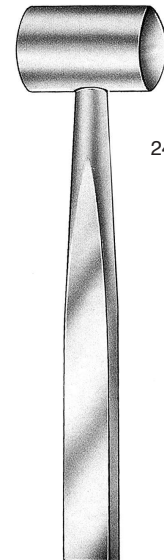

240 g

COTTLE
PM. 32.19 19 cm

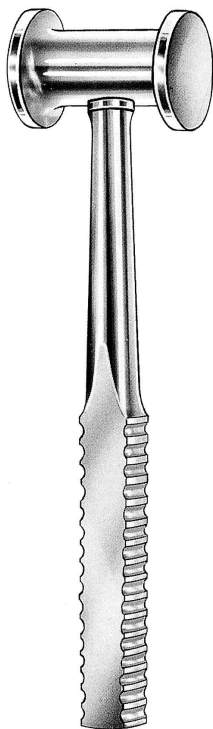

300 g

BERGMANN
PM. 35.24 24 cm

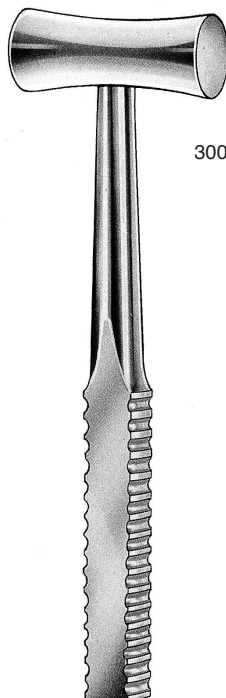

300 g

BERGMANN
PM. 37.23 23 cm

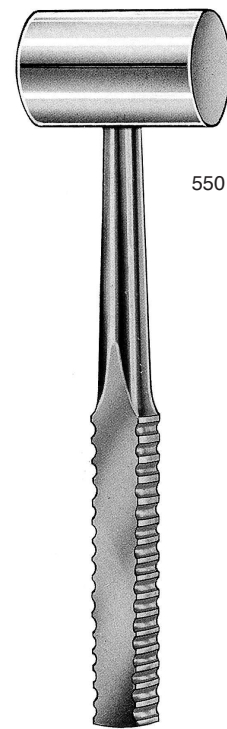

550 g

OMBREDANNE
PM. 38.55 24 cm

Bone files, Rasps

Knochenfeilen, Raspeln

Limas para huesos, Escofinas

Limes à os, Râpes à os



PUTTI
PT. 04.28 28 cm

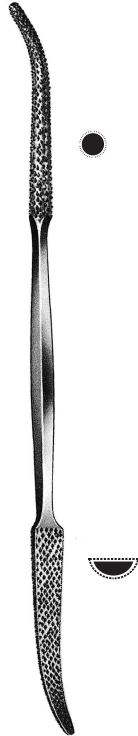

PUTTI
PT. 05.30 30 cm



PT. 06.22 22 cm



PT. 07.28 28 cm



PT. 08.24 24 cm

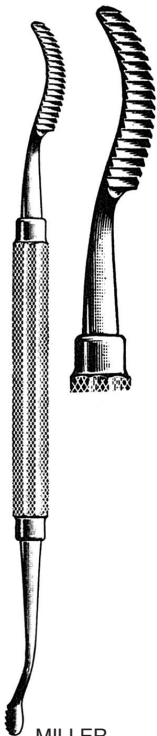

MILLER
PT. 10.30 18 cm

10

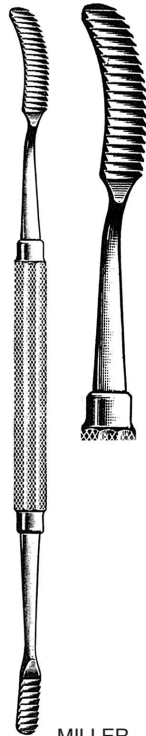

MILLER
PT. 10.40 18 cm

11

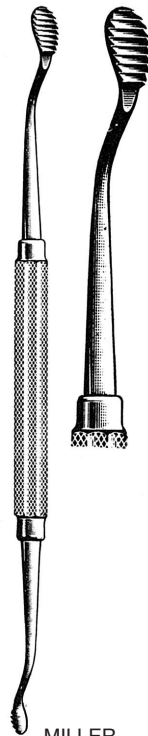

MILLER
PT. 10.45 18 cm

12

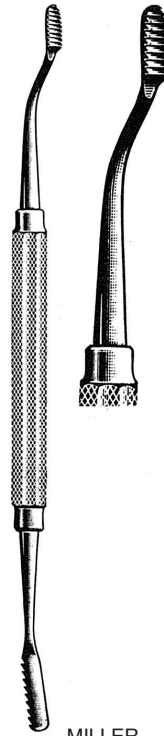

MILLER
PT. 10.50 18 cm

13

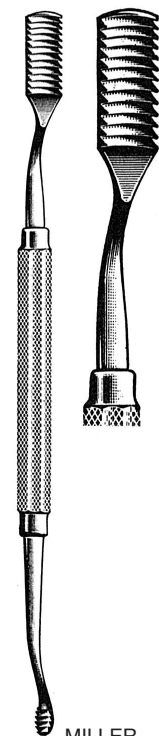

MILLER
PT. 10.55 18 cm

14

Elevators

Elevatorii
Elevadores
Elévateurs

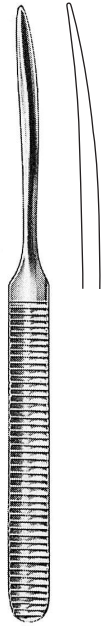

WILLIGER
16 cm
PT. 12.04 4 mm

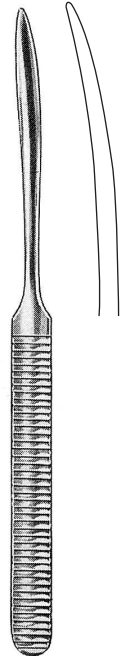

WILLIGER
16 cm
PT. 12.06 5.5 mm
PT. 12.07 7 mm

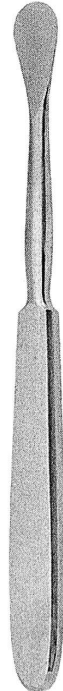

HOEN

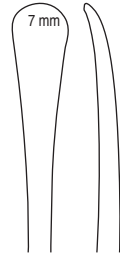

PT. 14.07
16 cm



PT. 14.15
19 cm

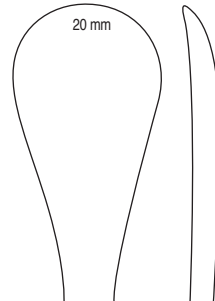

PT. 14.20
19 cm

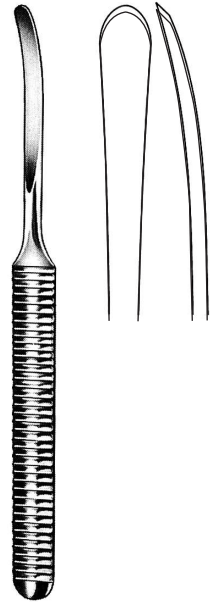

WILLIGER
16 cm
PT. 15.03 3 mm
PT. 15.05 5 mm
PT. 15.07 7 mm



McDONALD
PT. 18.19 19 cm



MOLT
PT. 19.18 18 cm



MOLT
PT. 19.19 18 cm



MOLT
PT. 19.20 18 cm



MOLT
PT. 19.21 18 cm

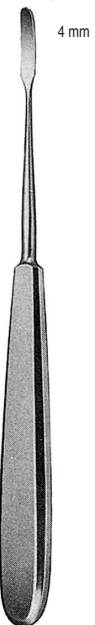

JOSEPH
PT. 22.16 16.5 cm

Elevators

Elevatori
Elevadores
Elévateurs

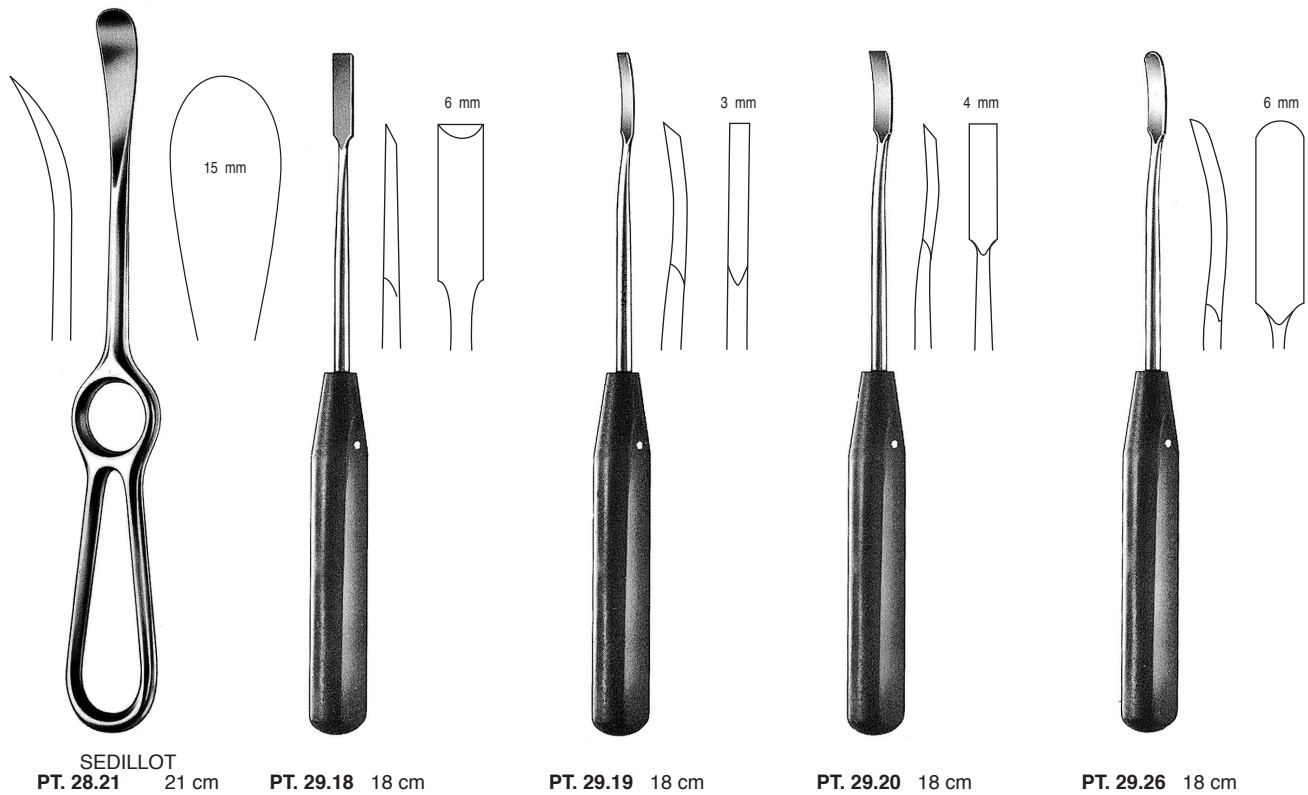
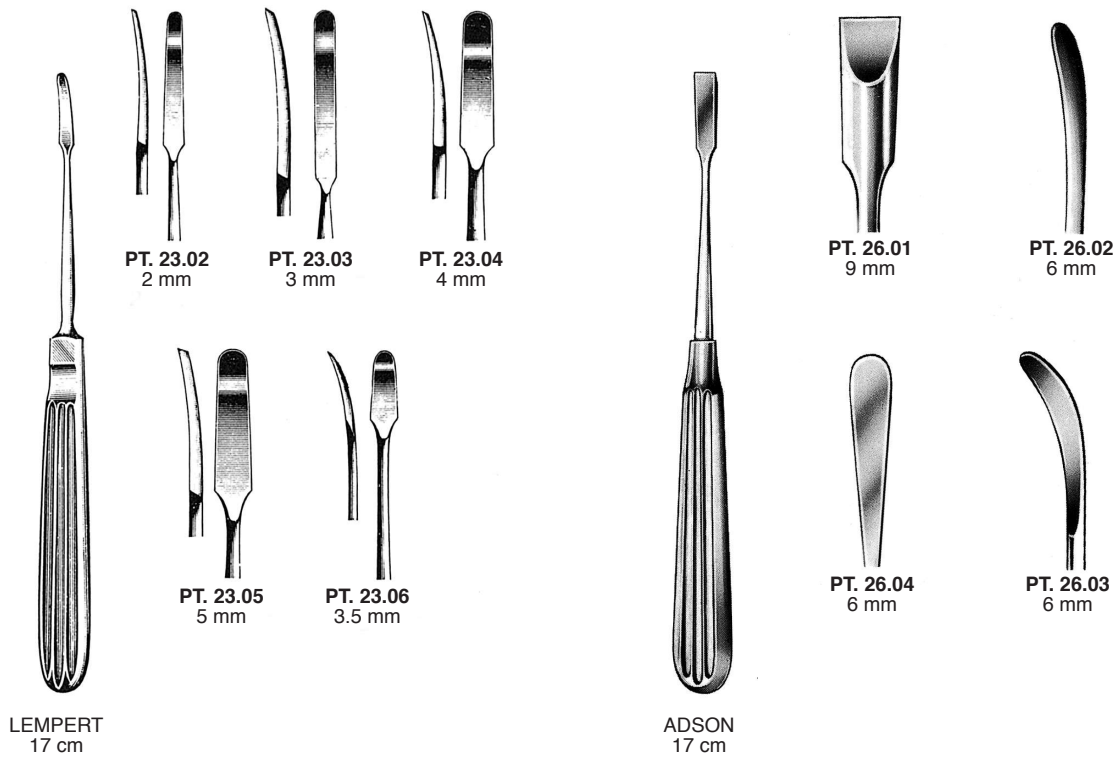

Raspatories
 Raspatorien
 Periostótomos
 Rugines

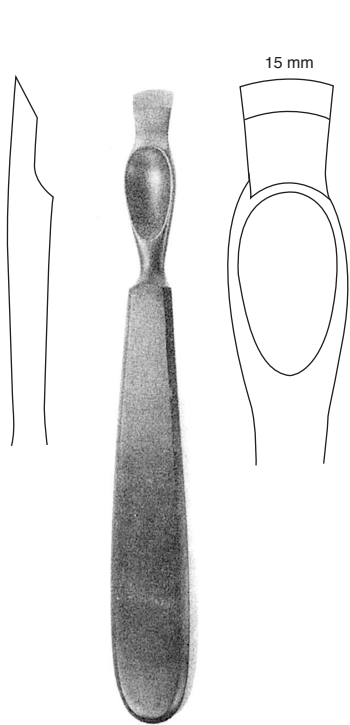

KIRMISSION
PT. 30.16 16.5 cm



SEMB



PT. 31.01
 12 mm
 20 cm

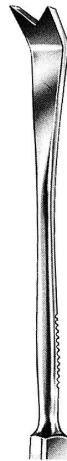

PT. 31.02
 12 mm
 24 cm

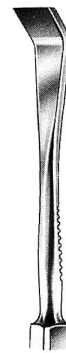

PT. 31.03
 14 mm
 20 cm



PT. 31.04
 14 mm
 24 cm



PT. 31.07
 16 mm
 24 cm



Straight
PT. 32.15 15 cm



Curved
PT. 32.16

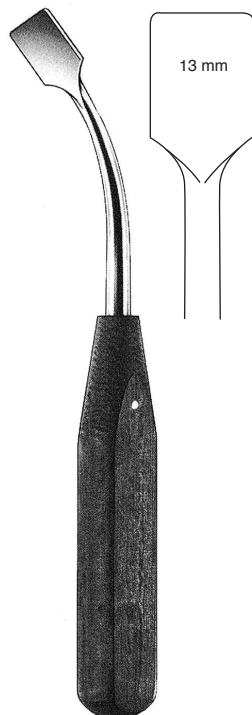

PT. 33.20 19 cm



PT. 33.21 20 cm

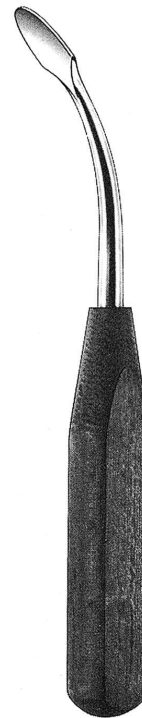

PT. 33.22 20 cm

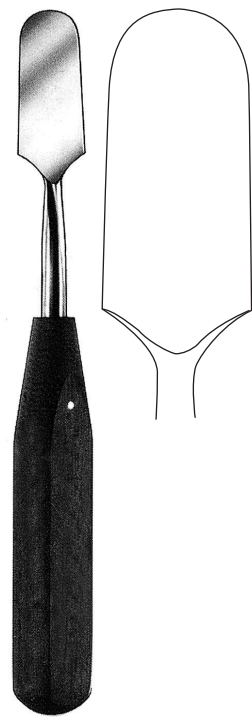

PT. 33.50 20 cm

Raspatories

Raspatorien
Periostótomos
Rugines

Elevators

Elevatorien
Elevadores
Elévateurs



LAMBOTTE
21 cm

- PT. 34.06 6 mm
- PT. 34.10 10 mm
- PT. 34.15 15 mm
- PT. 34.20 20 mm
- PT. 34.25 25 mm

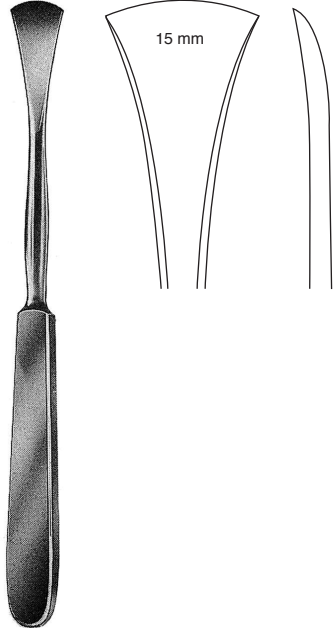

LANGENBECK
PT. 37.35 19 cm

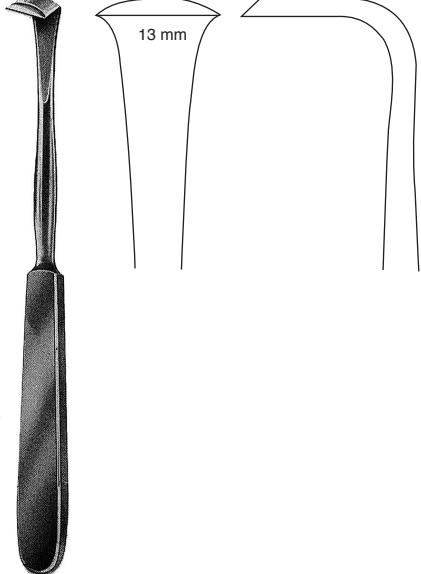

LANGENBECK
PT. 37.63 18 cm

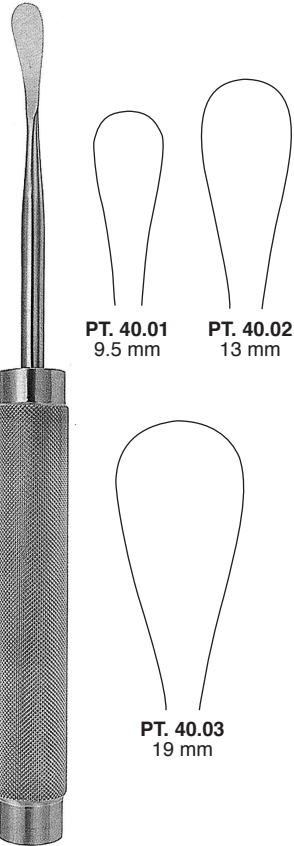

COBB
28 cm

PT. 40.01
9.5 mm

PT. 40.02
13 mm

PT. 40.03
19 mm

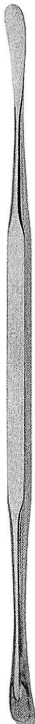

ALDERDYCE
PT. 41.21 21 cm



FREER
PT. 42.18 18 cm



FREER
19 cm

PT. 43.19
Sharp

PT. 43.29
Blunt



PT. 44.18 17.5 cm



PT. 45.16 16 cm

Elevators

Elevatorien
Elevadores
Elévateurs

Raspatories

Raspatorien
Periostótomos
Rugines

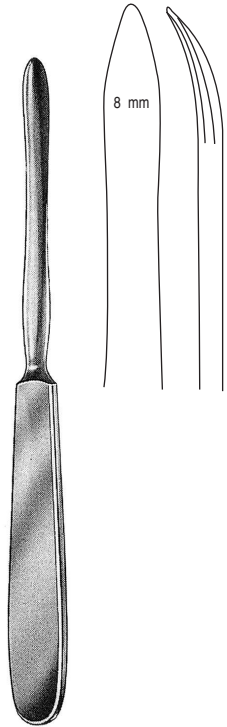

LANGENBECK
PT. 46.08 19.5 cm

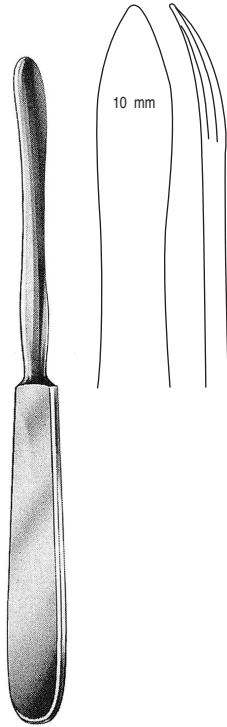

LANGENBECK
PT. 46.10 19.5 cm

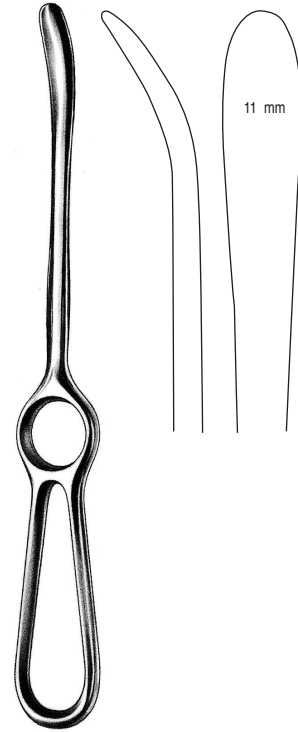

LANGENBECK
PT. 47.11 23 cm

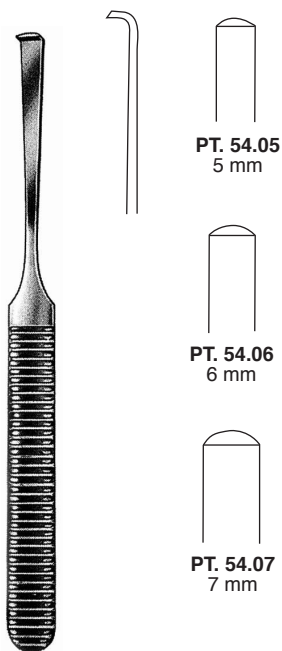

16 cm

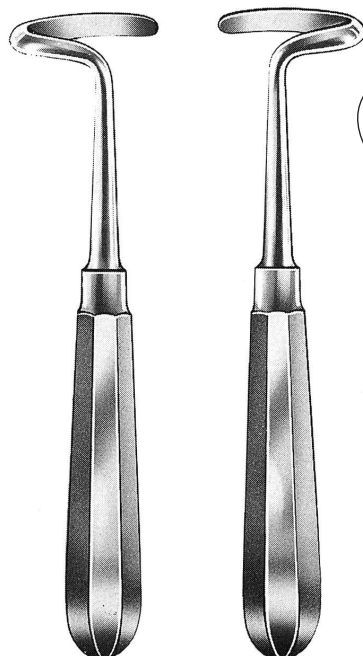

DOYEN
17 cm

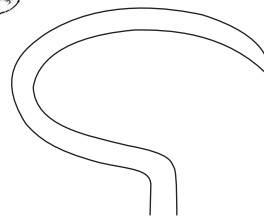

PAG. 46.11

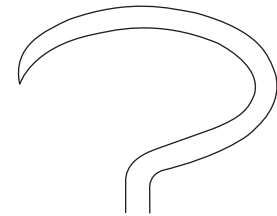

PAG. 46.12

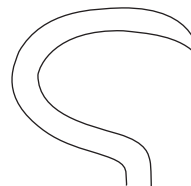

PAG. 46.21

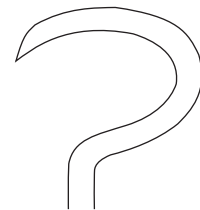

PAG. 46.22

Bone levers

Knochenhebel

Elevadores para huesos

Levier à os

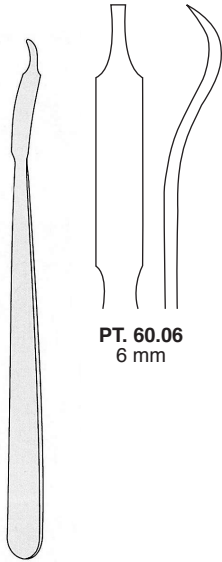

MINI-HOHMANN
16 cm

PT. 60.06
6 mm

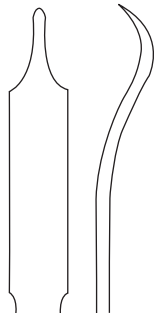

PT. 60.08
8 mm

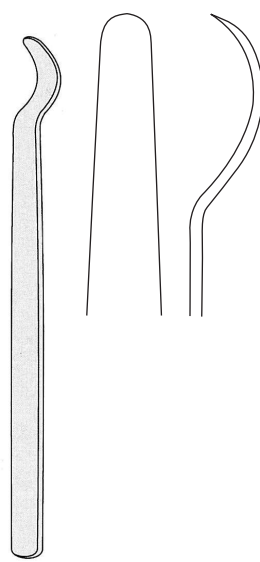

PT. 61.14
14 cm

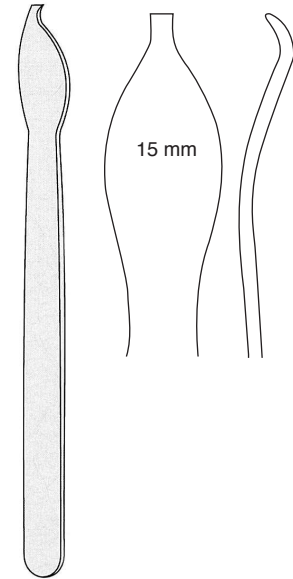

PT. 61.37
17 cm

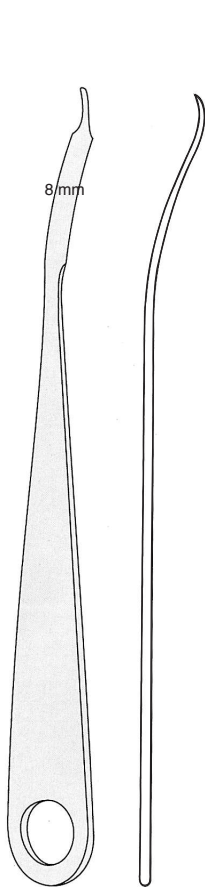

HOHMANN
PT. 62.08 22 cm

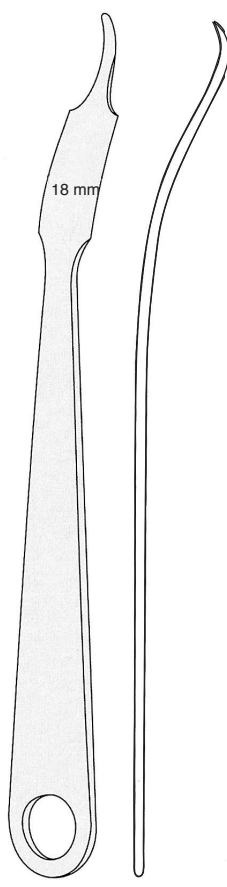

HOHMANN
PT. 62.18 24 cm

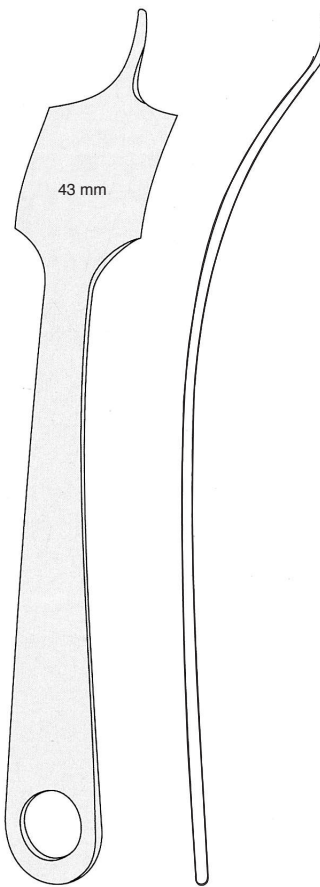

HOHMANN
PT. 62.43 26 cm

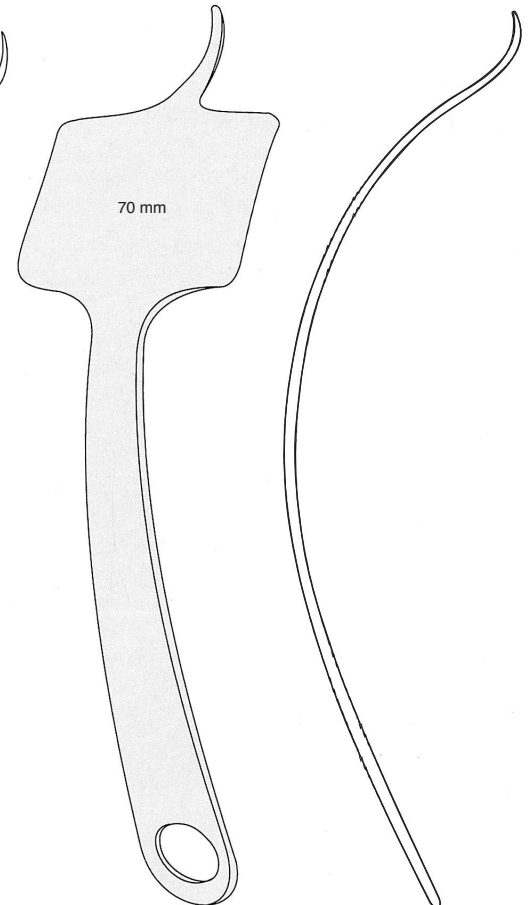

HOHMANN
PT. 62.70 29 cm

Bone levers
 Knochenhebel
 Elevadores para huesos
 Levier à os

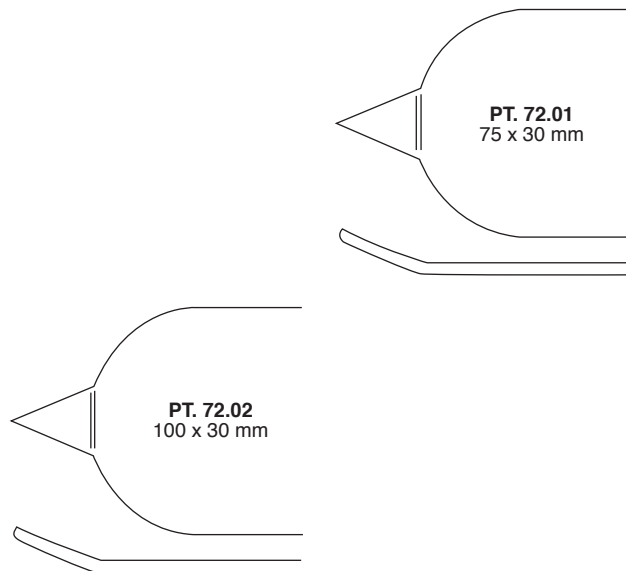
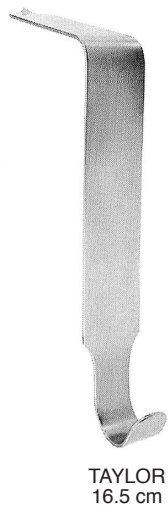
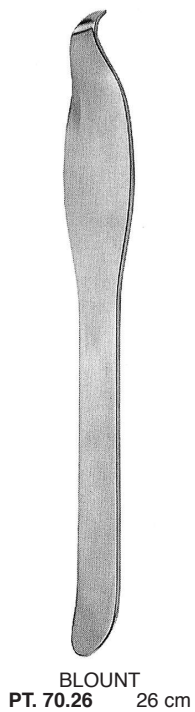
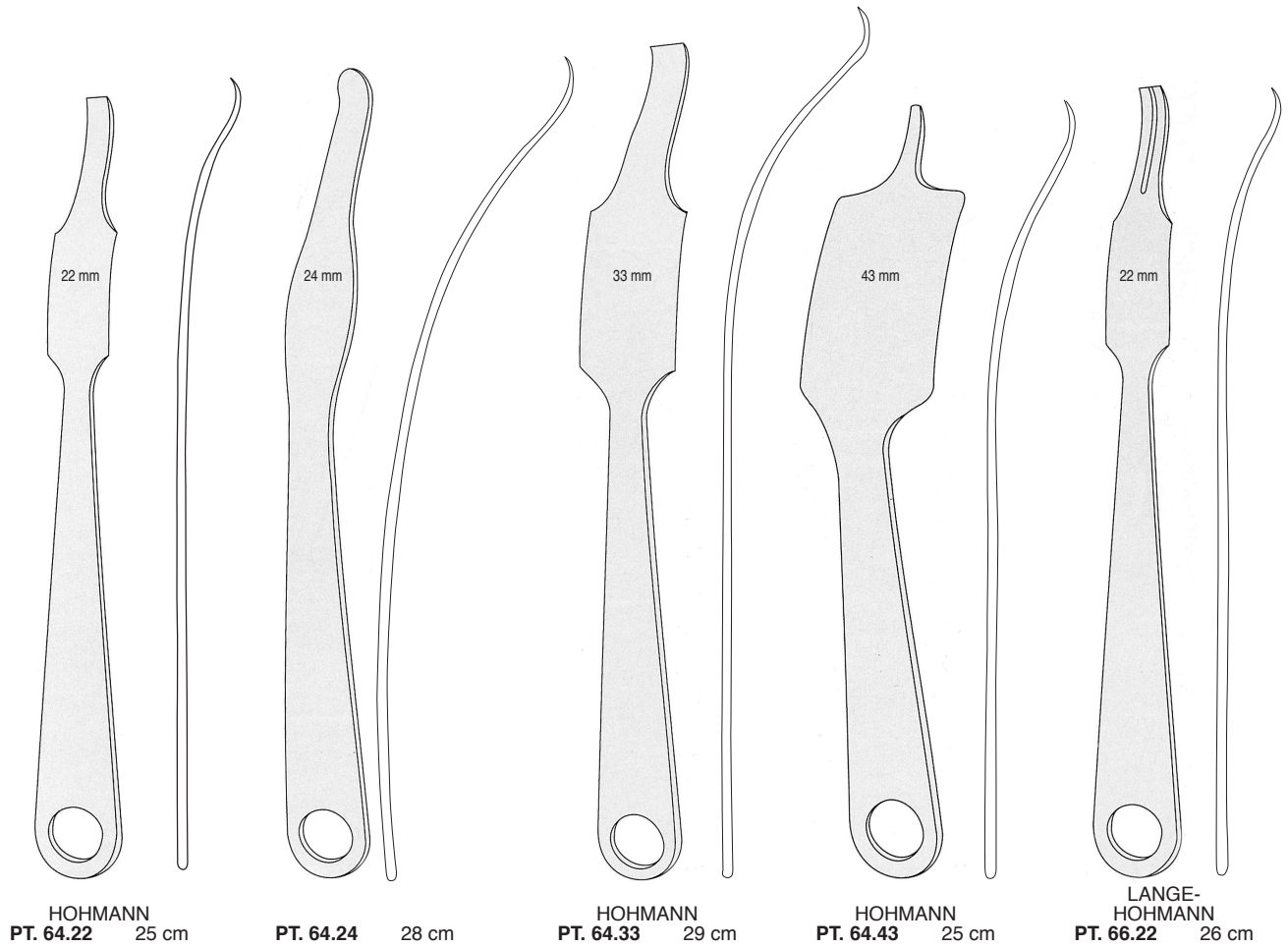

Knee retractors

Wund-und Meniskushaken

Separadores para rodilla

Ecarteurs pour le genou

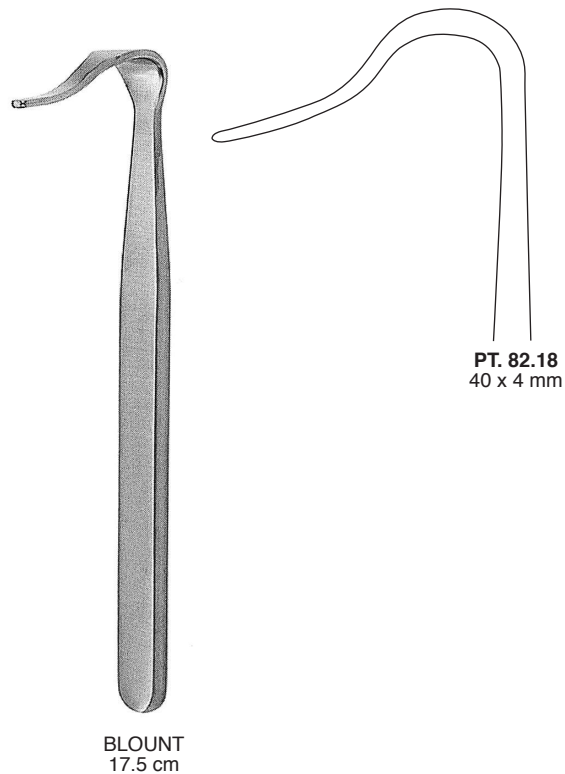
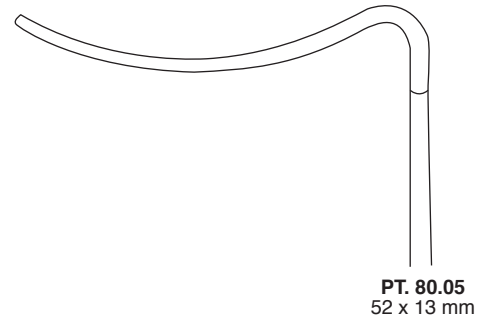
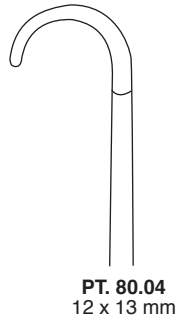
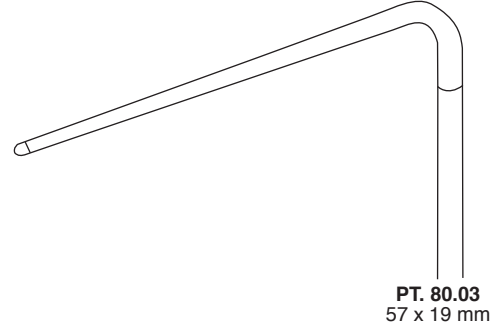
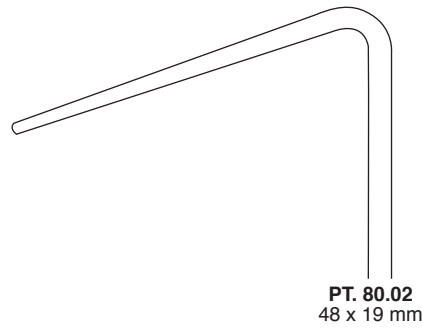
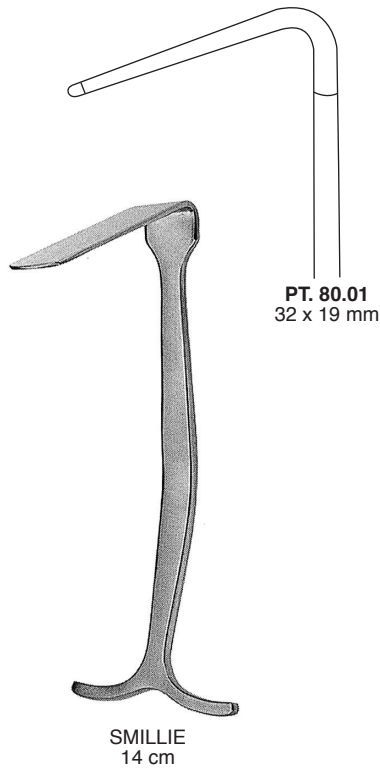

Bone cutting forceps

Knochensplitterzangen

Pinzas cortantes para huesos

Pinces coupantes

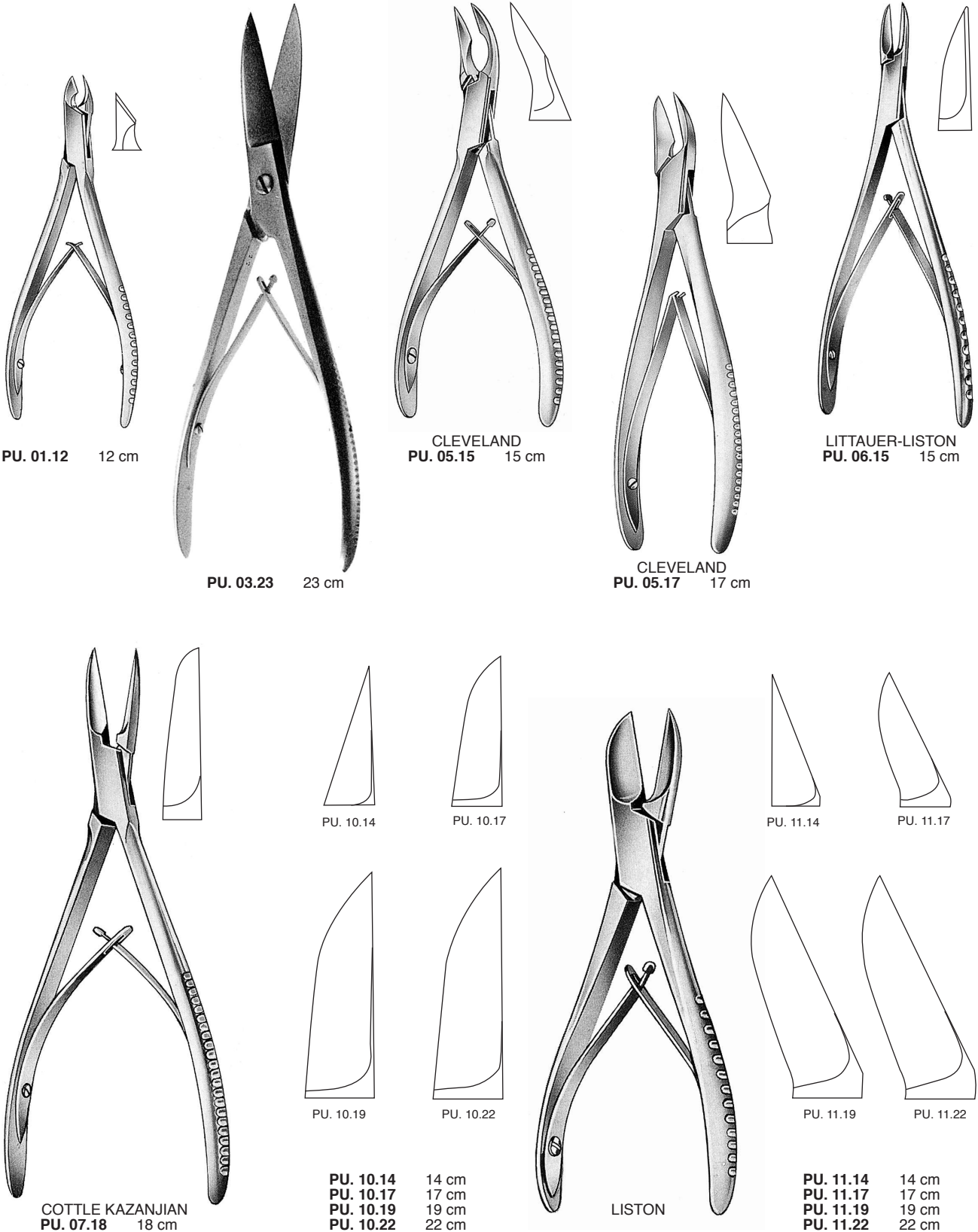

Bone cutting forceps

Knochensplitterzangen

Pinzas cortantes para huesos

Pinces coupantes

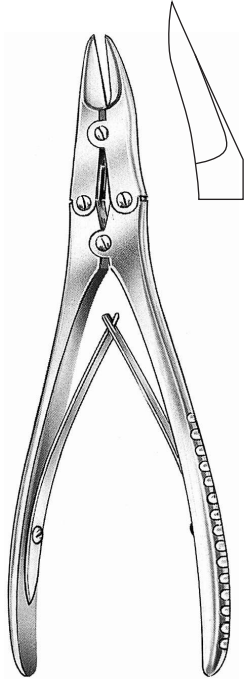

MCINDOE
Straight
 PU. 15.18 17.5 cm
Angled
 PU. 15.19

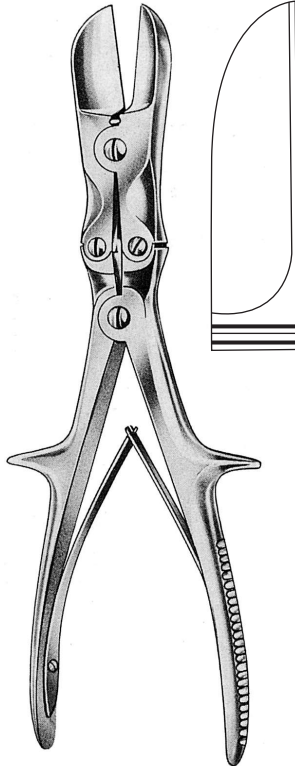

LISTON-STILLE
 PU. 17.27 27 cm

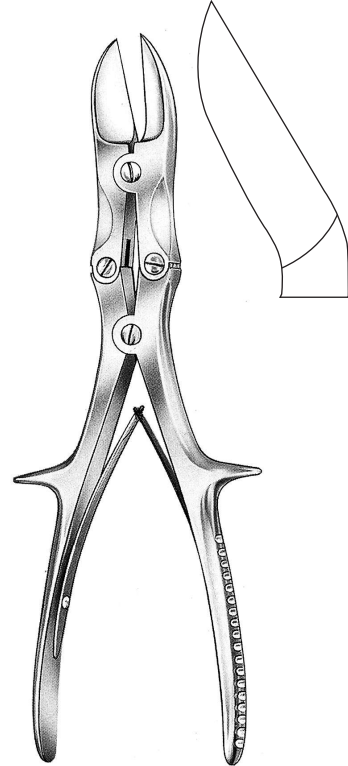

LISTON
Straight
 PU. 18.24 17.5 cm
Angled
 PU. 18.25

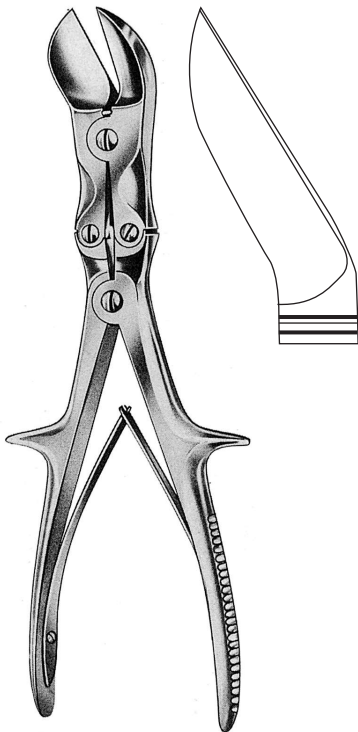

LISTON-STILLE
 PU. 18.27 27 cm

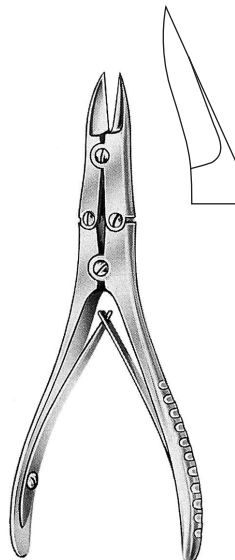

LISTON-MINI
Straight
 PU. 20.15 15 cm
Angled
 PU. 21.15

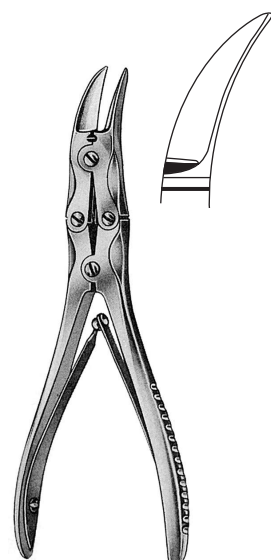

KLEINERT-KUTZ
 PU. 22.15 15 cm

Bone cutting forceps

Knochensplitterzangen

Pinzas cortantes para huesos

Pinces coupantes

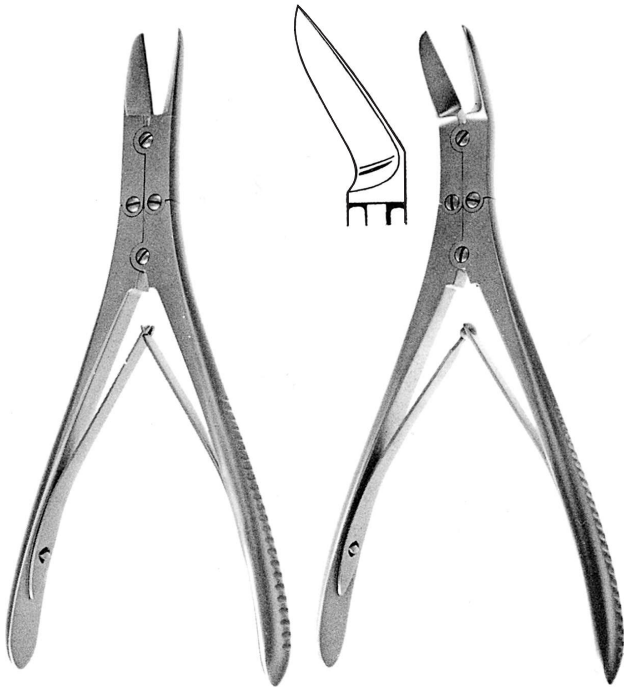

RUSKIN-ROWLAND
PU. 23.18 18 cm

RUSKIN-ROWLAND
PU. 24.18 18 cm

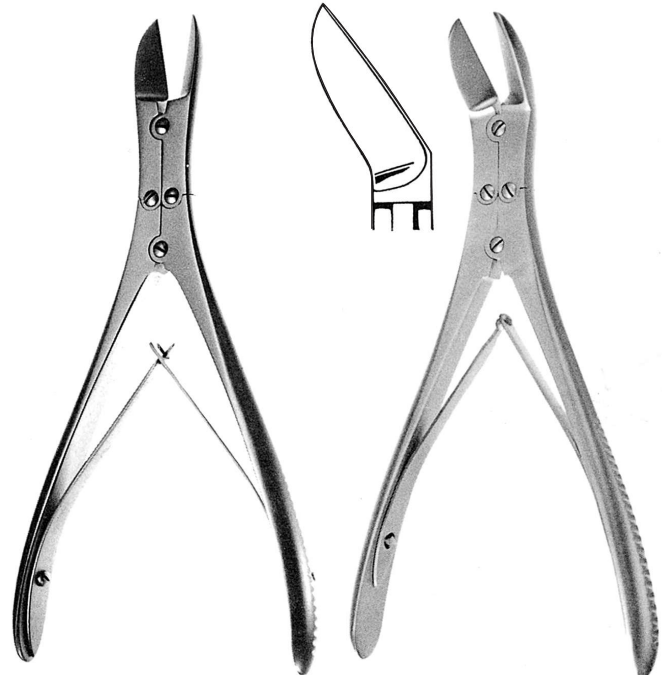

RUSKIN-LISTON
PU. 25.18 18 cm

RUSKIN-LISTON
PU. 26.18 18 cm

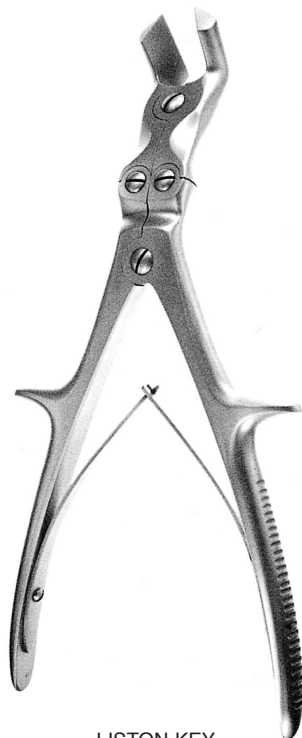

LISTON-KEY
(HORSLEY-STILLE)
PU. 28.27 27 cm



SEMB
PU. 29.23 23 cm

Bone holding forceps & clamps

Knochenhaltezaugen & -klammern

Pinzas para huesos y porte huesos

Daviers

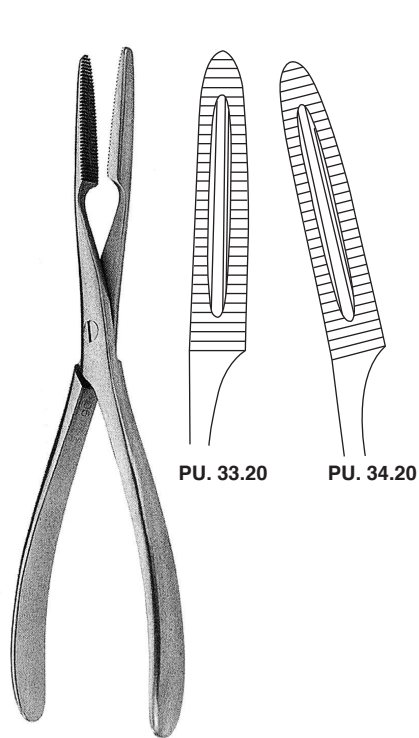

PU. 33.20

PU. 34.20

20 cm

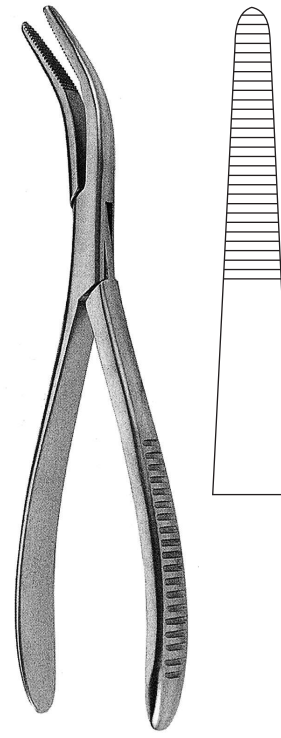

VAN BUREN
PU. 35.23 23 cm

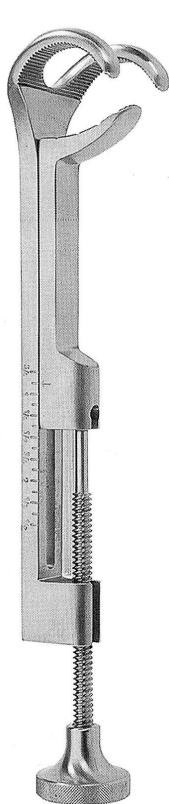

LOWMANN

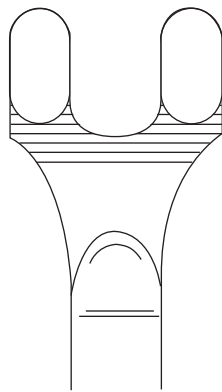

PU. 35.18 18 cm

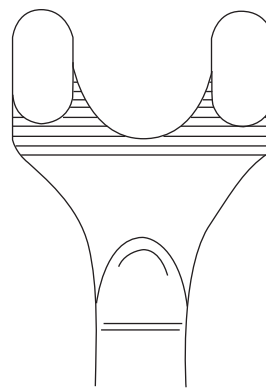

PU. 35.20 20 cm

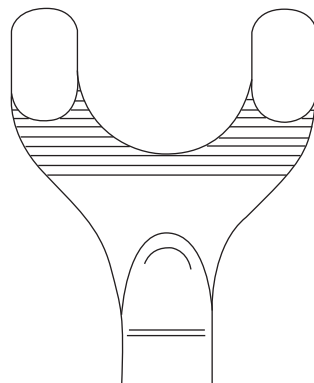

PU. 35.22 22 cm

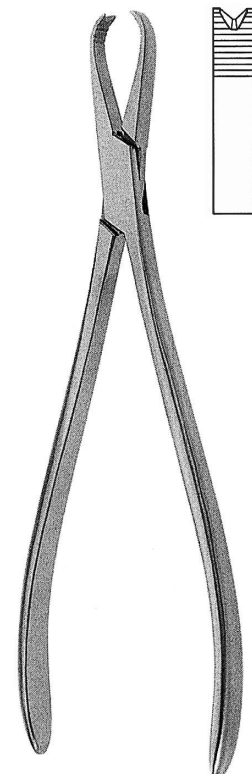

PU. 36.20 20 cm

Bone holding forceps

Knochenhaltezangen

Pinzas para huesos

Daviers

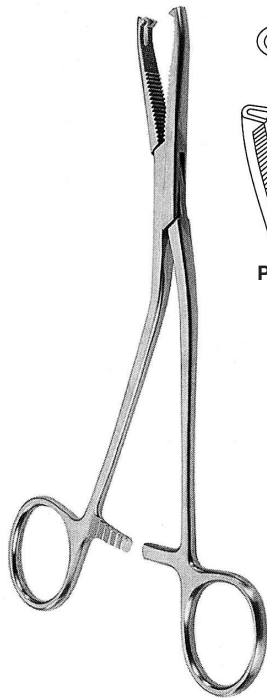

DINGMANN
19 cm

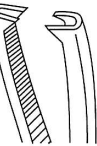

PU. 38.19

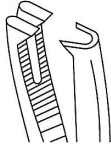

PU. 39.19

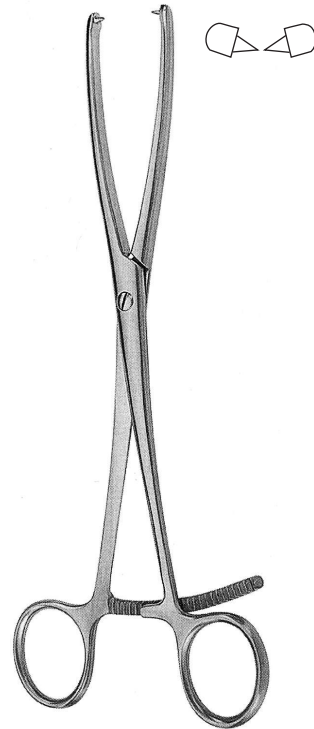

PU. 40.21 21 cm

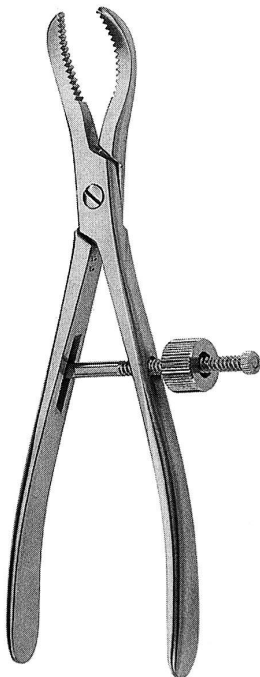

PU. 41.16 16 cm

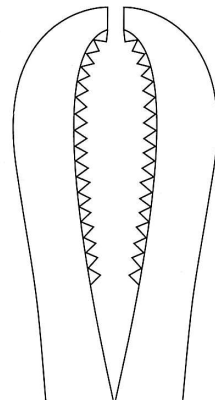
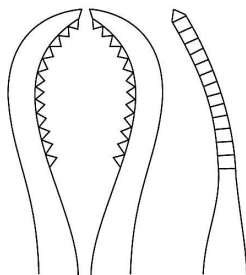

PU. 42.22 22 cm

Bone holding forceps
 Knochenhaltezangen
 Pinzas para huesos
 Daviers

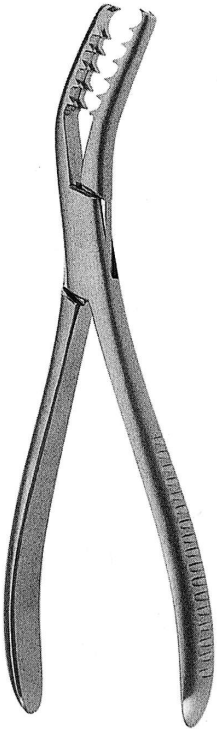

SEMB
 PU. 43.20 20 cm

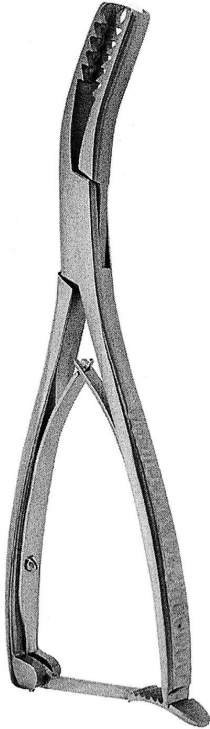

SEMB
 PU. 44.20 20 cm



PU. 46.14 13.5 cm

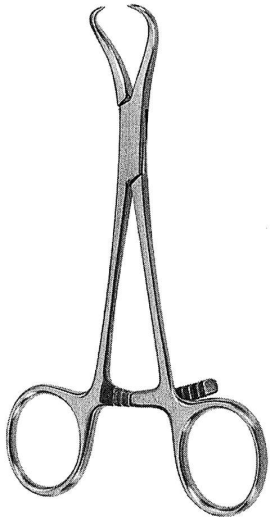

PU. 31.13 13.5 cm

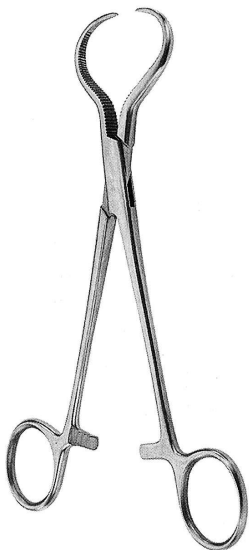

LEWIN
 PU. 48.18 17.5 cm

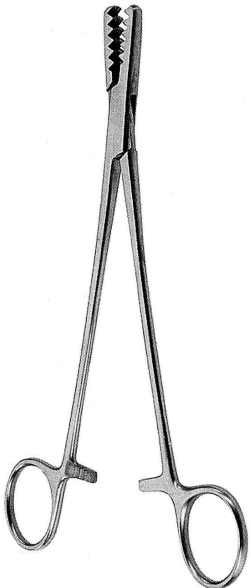

MARTIN
 PU. 50.19 19 cm

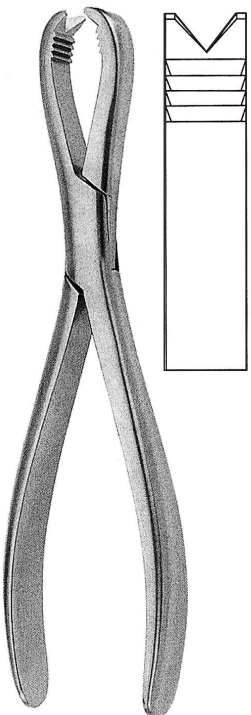

LANGENBECK
 PU. 51.21 21 cm

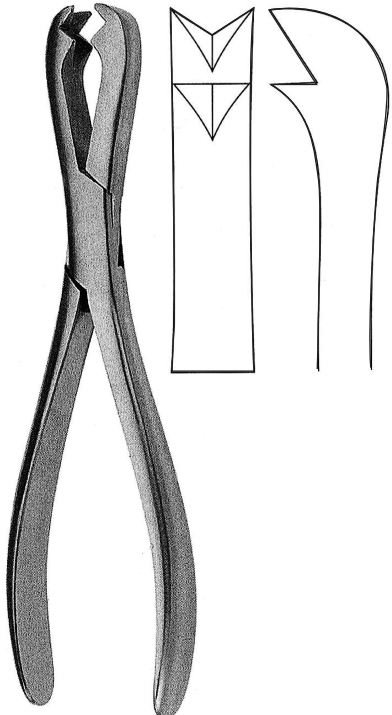

FERGUSSON
 PU. 52.21 21 cm

Bone holding forceps

Knochenhaltezaugen

Pinzas para huesos

Daviers

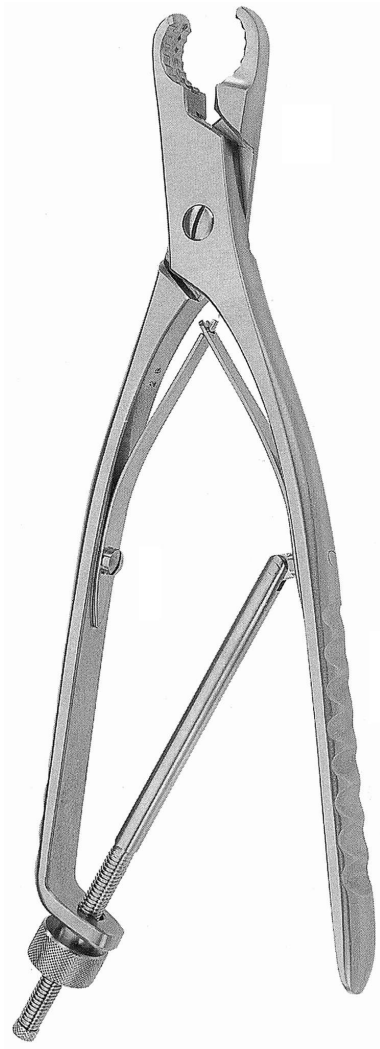

ULRICH
PU. 55.23
PU. 55.25
PU. 55.28

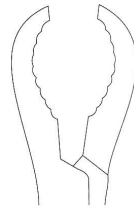

PU. 55.23
PU. 55.24
23 cm

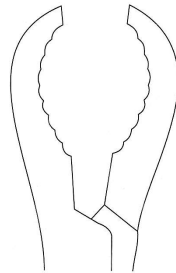

PU. 55.25
PU. 55.26
25 cm

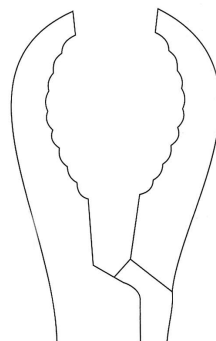

PU. 55.28
PU. 55.29
28 cm

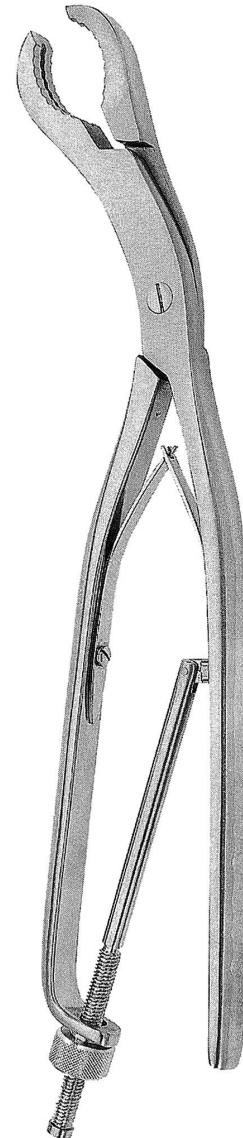

ULRICH
PU. 55.24
PU. 55.26
PU. 55.29

Bone holding forceps

Knochenhaltezenen

Pinzas para huesos

Daviers



KERN
PU. 56.14 14 cm
PU. 56.17 17 cm
PU. 61.23 23 cm

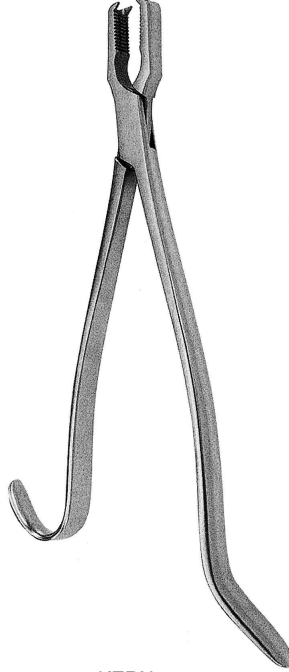

KERN
PU. 57.14 14 cm
PU. 57.17 17 cm
PU. 60.23 23 cm

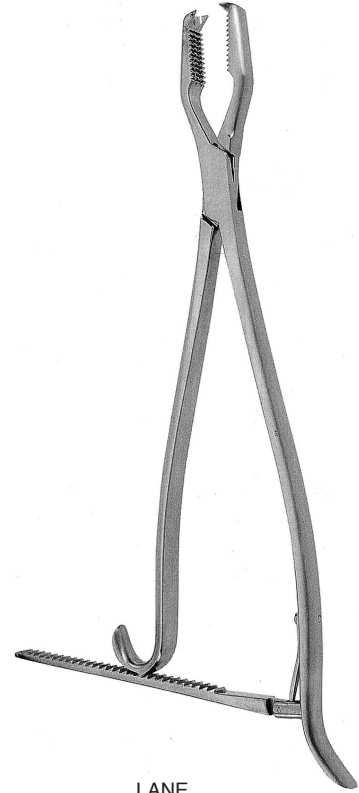

LANE
 Without Ratchet **PU. 58.33** 33 cm
 With Ratchet **PU. 59.33** 33 cm
PU. 58.45 45 cm **PU. 59.45** 45 cm

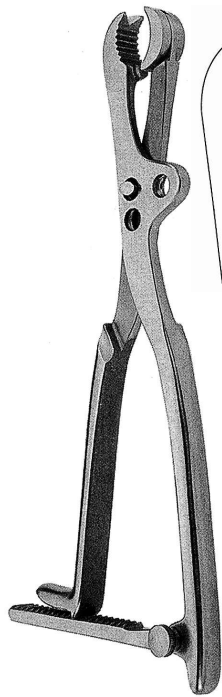

LAMBOTTE
PU. 62.21 21 cm
PU. 62.25 25 cm
PU. 62.30 30 cm

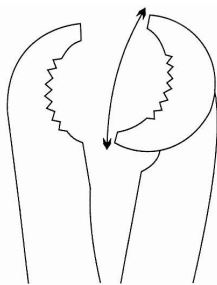

LAMBOTTE
PU. 63.21 21 cm
PU. 63.26 26 cm
PU. 63.33 30 cm

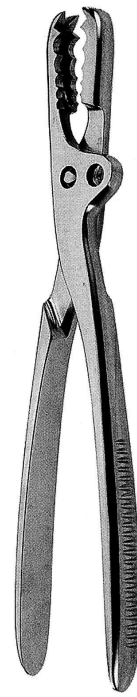
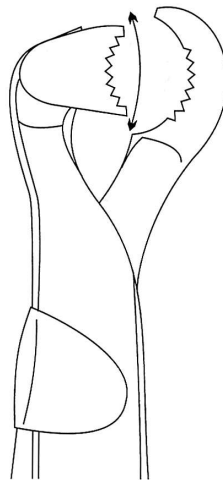

FARABEUF
PU. 64.25 25 cm

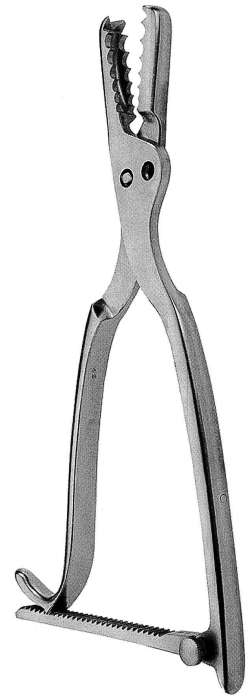

FARABEUF-LAMBOTTE
PU. 65.26 26 cm

Bone holding forceps

Knochenhaltezaugen

Pinzas para huesos

Daviers

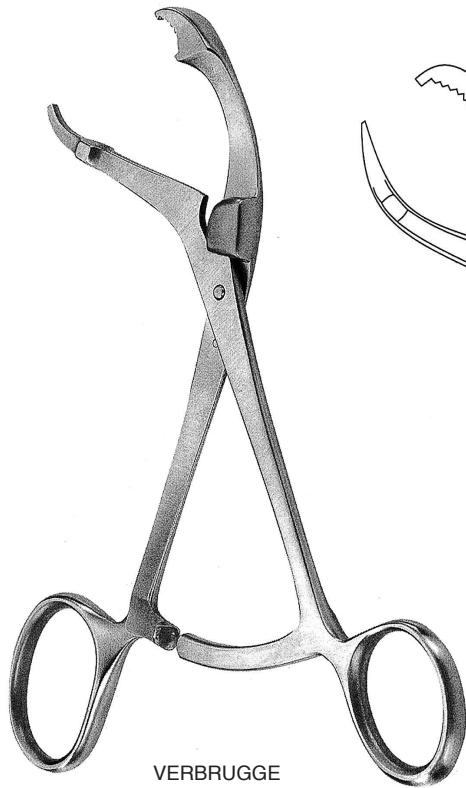

VERBRUGGE

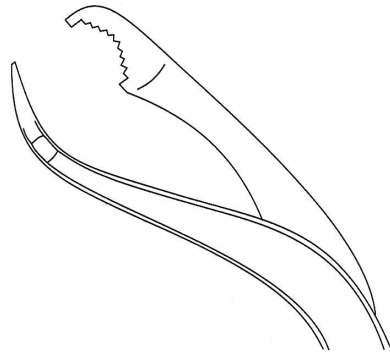

PU. 66.17 17.5 cm

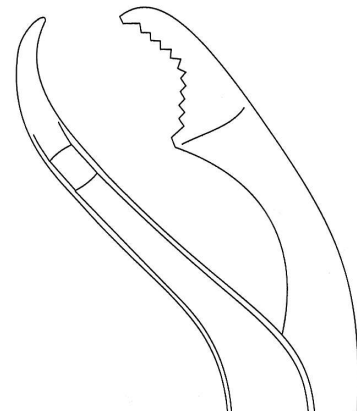

PU. 67.25 25 cm

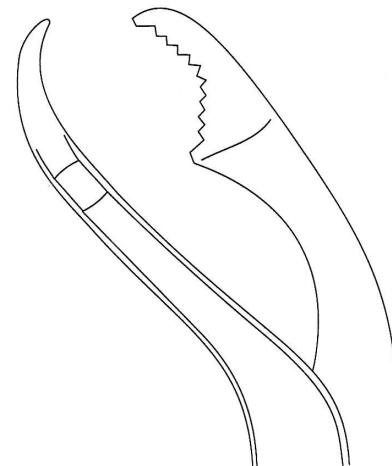

PU. 67.26 26 cm

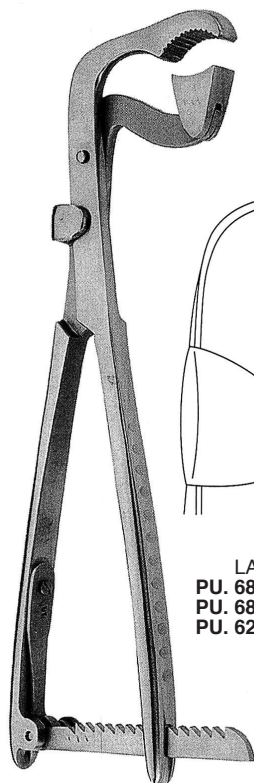

LAMBOTTE
 PU. 68.19 19 cm
 PU. 68.23 23 cm
 PU. 62.26 26 cm

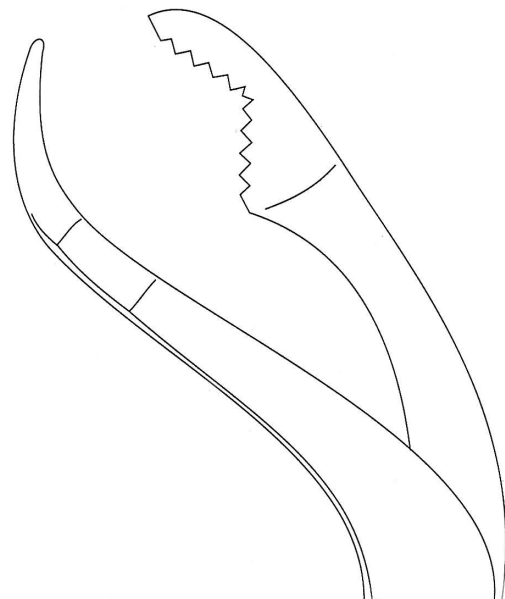
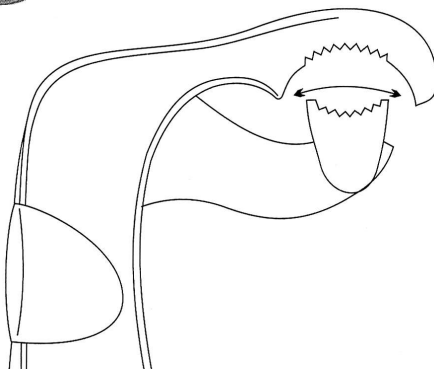

PU. 67.27 27 cm

Bone holding forceps

Knochenhaltezangen

Pinzas para huesos

Daviers

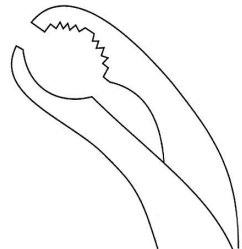

PU. 69.15 15 cm

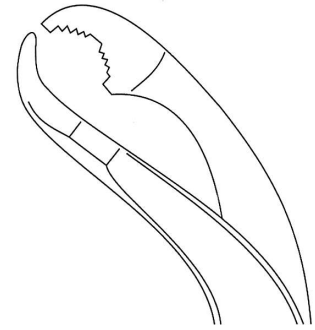

PU. 69.19 19 cm

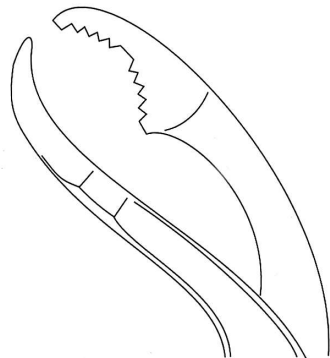

PU. 69.24 24 cm

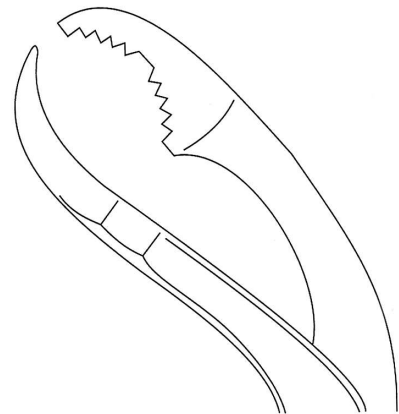

PU. 69.26 26 cm

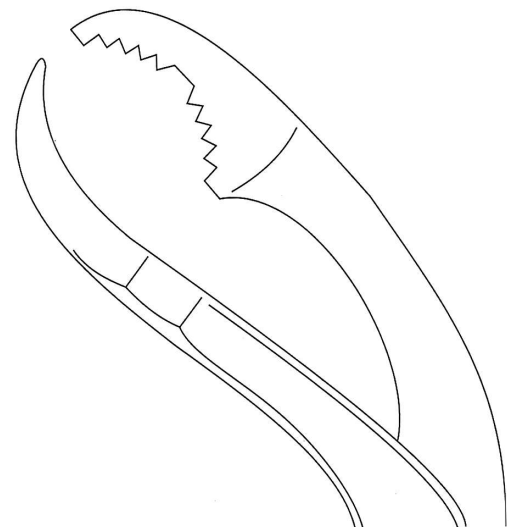
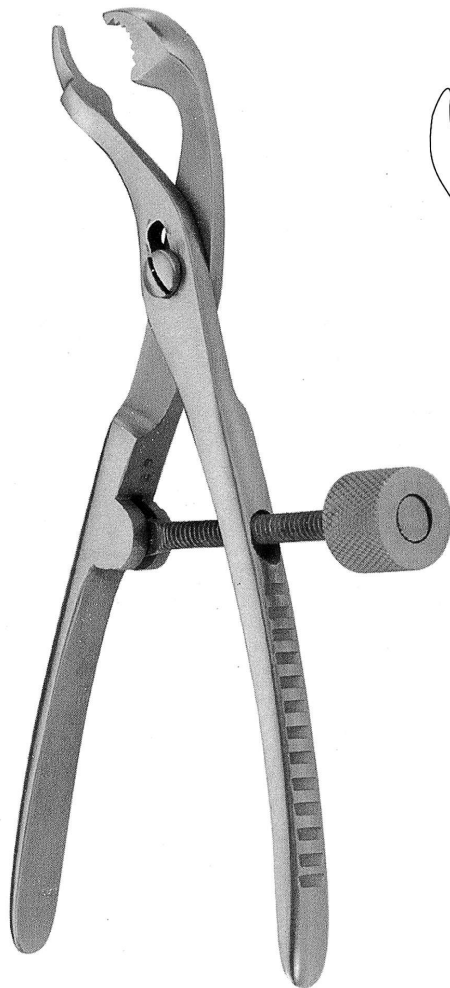

PU. 69.28 28 cm

Amputating & resection saws

Amputations- & Resektionssägen
Sierras para amputación y resección
Scies à amputation et résection



LANGENBECK
PU. 70.30 23 cm

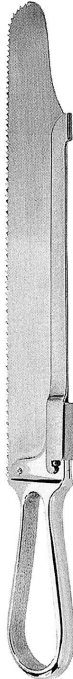

CHARRIERE
PU. 71.27 27 cm
PU. 71.30 30 cm
PU. 71.34 34 cm

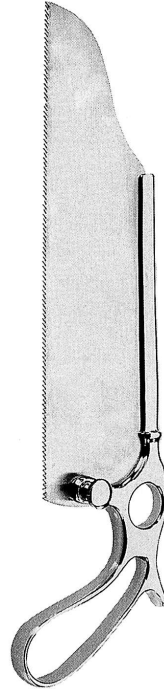

SATTERLEE
PU. 72.29 31 cm

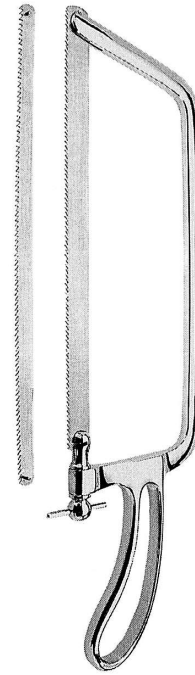

CHARRIERE
PU. 73.35 35 cm

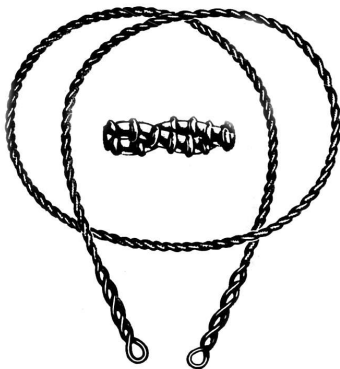

GIGLI
PU. 74.30 30 cm
PU. 74.40 40 cm
PU. 74.50 50 cm
PU. 74.60 60 cm
PU. 74.70 70 cm

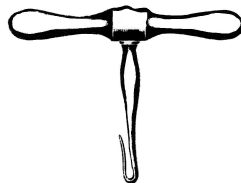

GIGLI
PU. 74.02

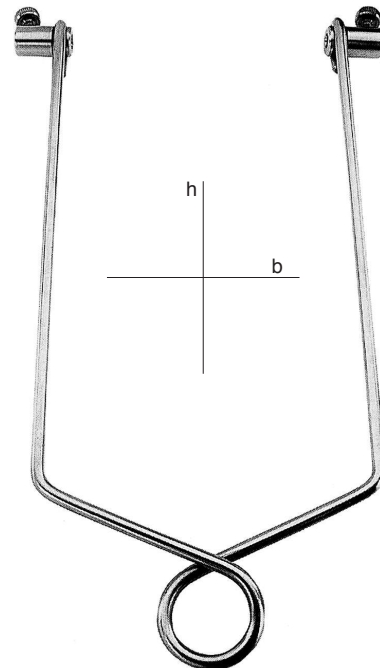

BÖHLER
h x b
PU. 76.01 16 x 9 cm
PU. 76.03 21 x 11 cm
PU. 76.05 21 x 15 cm

Wire forceps

Drahtzangen
Pinzas para hilos
Pincas à fil

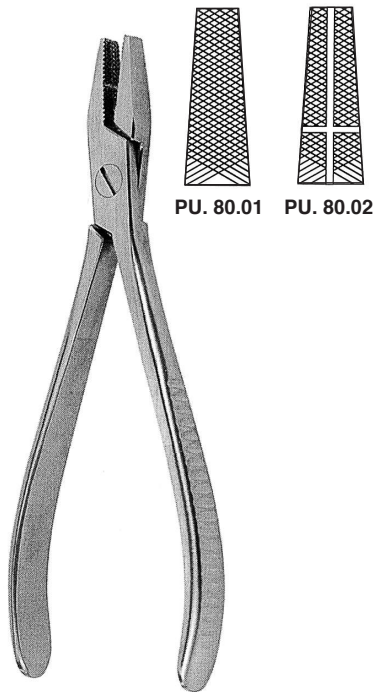

PU. 80.01 PU. 80.02

17 cm

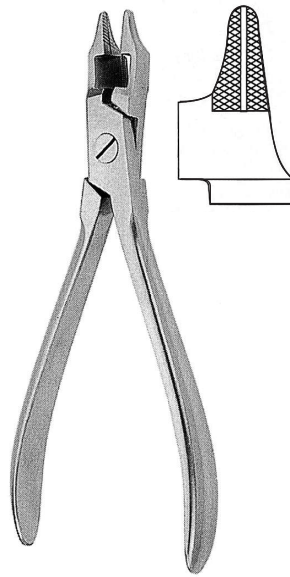

PU. 82.15
15 cm

Flat nose pliers, Wire twisting instruments

Flachzangen, Drahtspanninstrumente
Alicates planos, Tensores cierra-hilos
Pincas plates, Tendeurs sèrre-fils

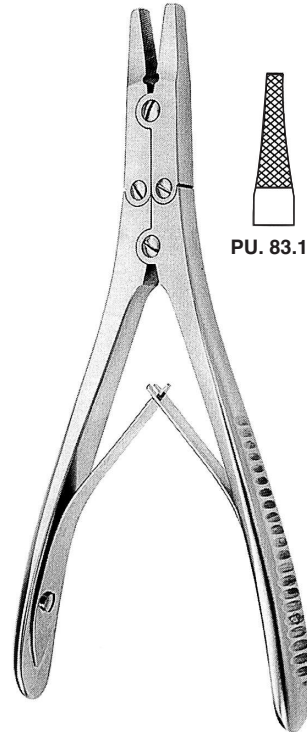

PU. 83.18 PU. 84.18 PU. 85.18

18 cm

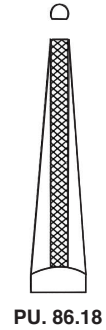

PU. 86.18

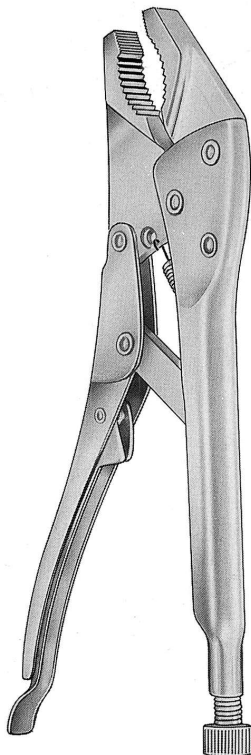

PU. 88.18 18 cm

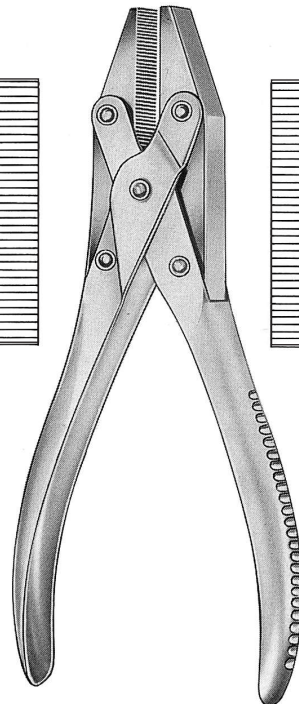

PU. 89.17 17 cm

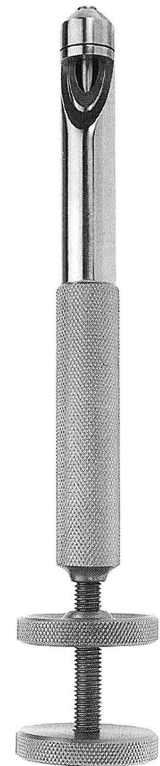
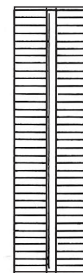

LOUTE
PU. 90.21 21 cm

Wire cutting pliers

Drahtkneifzangen
Alicates cortaalambres
Pincés coupe-fil

Wire cutting pliers, PROLONG TC®

Drahtkneifzangen, PROLONG TC®
Alicates cortaalambres, PROLONG TC®
Pincés coupe-fil, PROLONG TC®

Scissors with tungsten carbide cutting edges

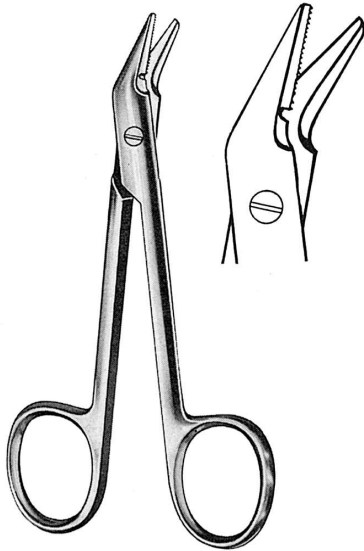

UNIVERSAL
PS. 23.12 12 cm

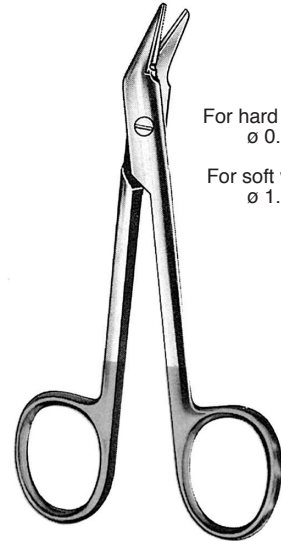

For hard wires upto
ø 0.8 mm
For soft wires upto
ø 1.2 mm

UNIVERSAL
PS. 24.12 12 cm

Pliers with tungsten carbide cutting edges

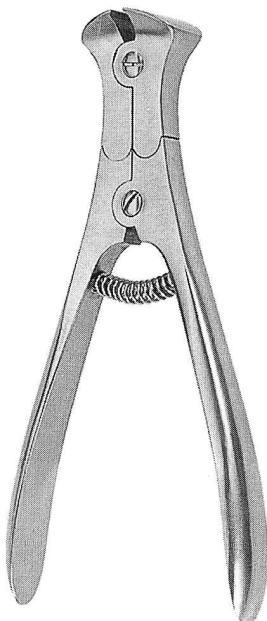

PU. 91.15 15 cm

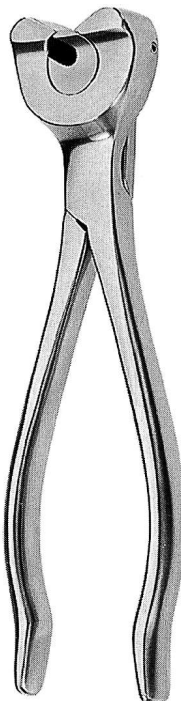

PU. 92.16 16 cm

For hard wires upto
ø 1.5 mm
For soft wires upto
ø 2.0 mm

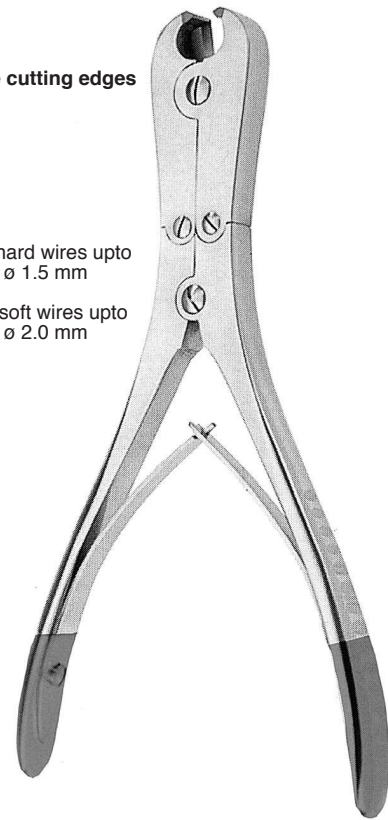

PU. 94.18 18 cm

Wire cutting pliers, **PROLONG TC**[®]
 Drahtkneifzangen, **PROLONG TC**[®]
 Alicates cortaambres, **PROLONG TC**[®]
 Pincas coupe-fil, **PROLONG TC**[®]

Pliers with tungsten carbide cutting edges

PU. 100.47
 For cutting off
 KIRCHNER wires,
 TIBIA head screw,
 bolts, pins upto
 ø 6.0 mm

PU. 100.56
PROLONG TC[®]
 For hard wires upto
 ø 2.5 mm

For hard wires upto
 ø 2.5 mm

For hard wires upto
 ø 1.6 mm

For soft wires upto
 ø 2.0 mm



PU. 96.17 17 cm



PU. 98.22 22 cm



MEGA CUT
PU. 100.47 47 cm
PU. 100.56 56 cm

Chisels & Gouges

Flach- & Hohlmeißel

Cinceles y Gubias

Ciseaux-burins et Gouges

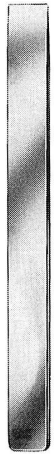

MINI-LAMBOTTE
13 cm

PV. 01.02	2 mm
PV. 01.04	4 mm
PV. 01.06	6 mm
PV. 01.08	8 mm
PV. 01.10	10 mm
PV. 01.12	12 mm
PV. 01.15	15 mm



TRAUTMANN
11 cm

PV. 04.12	2 mm
PV. 04.14	4 mm
PV. 04.16	6 mm
PV. 04.18	8 mm
PV. 04.20	10 mm



TRAUTMANN
11 cm

PV. 04.72	2 mm
PV. 04.74	4 mm
PV. 04.76	6 mm
PV. 04.78	8 mm
PV. 04.80	10 mm



13.5 cm

PV. 05.02	
PV. 05.03	
PV. 05.04	
PV. 05.05	
PV. 05.06	
PV. 05.07	
PV. 05.08	

17 cm

PV. 05.52	2 mm
PV. 05.53	3 mm
PV. 05.54	4 mm
PV. 05.55	5 mm
PV. 05.56	6 mm
PV. 05.57	7 mm
PV. 05.58	8 mm



13.5 cm

PV. 06.02	
PV. 06.03	
PV. 06.04	
PV. 06.05	
PV. 06.06	
PV. 06.07	
PV. 06.08	

PV. 06.52	
PV. 06.53	
PV. 06.54	
PV. 06.55	
PV. 06.56	
PV. 06.57	
PV. 06.58	

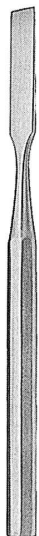

HOKE
14 cm

PV. 13.03	3 mm
PV. 13.04	5 mm
PV. 13.06	6 mm
PV. 13.08	8 mm
PV. 13.10	10 mm
PV. 13.12	12 mm

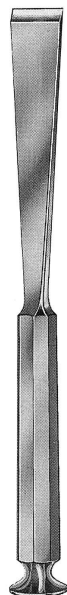

PV. 11.06	6 mm
PV. 11.08	8 mm
PV. 11.10	10 mm
PV. 11.12	12 mm
PV. 11.15	15 mm
PV. 11.20	20 mm
PV. 11.25	25 mm
PV. 11.30	30 mm

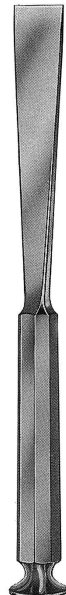

PV. 12.06	6 mm
PV. 12.08	8 mm
PV. 12.10	10 mm
PV. 12.12	12 mm
PV. 12.15	15 mm
PV. 12.20	20 mm
PV. 12.25	25 mm
PV. 12.30	30 mm



STILLE
20 cm

PV. 16.08	8 mm
PV. 16.10	10 mm
PV. 16.12	12 mm
PV. 16.15	15 mm
PV. 16.20	20 mm
PV. 16.25	25 mm



PV. 16.58	8 mm
PV. 16.60	10 mm
PV. 16.62	12 mm
PV. 16.65	15 mm
PV. 16.70	20 mm
PV. 16.75	25 mm

Chisels, Gouges and Osteotomes

Meißel und Osteotome

Cinceles, Gubias, Osteótomos

Ciseaux-Burins, Cinceles y Osteótomos

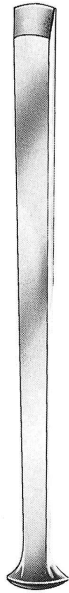

ALEXANDER
18 cm

PV. 17.04	4 mm
PV. 17.06	6 mm
PV. 17.08	8 mm
PV. 17.10	10 mm
PV. 17.12	12 mm
PV. 17.14	14 mm



ALEXANDER
18 cm

PV. 18.04	4 mm
PV. 18.06	6 mm
PV. 18.08	8 mm
PV. 18.10	10 mm
PV. 18.12	12 mm
PV. 18.14	14 mm



STILLE
16 cm

PV. 19.06	6 mm
PV. 19.08	8 mm
PV. 19.10	10 mm
PV. 19.12	12 mm
PV. 19.15	15 mm

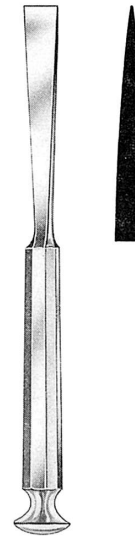

STILLE
16 cm

PV. 20.04	4 mm
PV. 20.06	6 mm
PV. 20.08	8 mm
PV. 20.10	10 mm
PV. 20.12	12 mm
PV. 20.15	15 mm

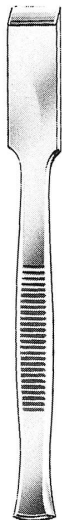

13.5 cm

PV. 23.03	3 mm
PV. 23.04	4 mm
PV. 23.06	6 mm
PV. 23.08	8 mm
PV. 23.10	10 mm
PV. 23.12	12 mm
PV. 23.14	14 mm
PV. 23.16	16 mm

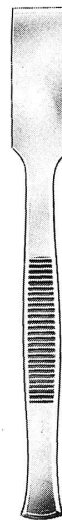

13.5 cm

PV. 24.03	3 mm
PV. 24.04	4 mm
PV. 24.06	6 mm
PV. 24.08	8 mm
PV. 24.10	10 mm
PV. 24.12	12 mm
PV. 24.14	14 mm
PV. 24.16	16 mm

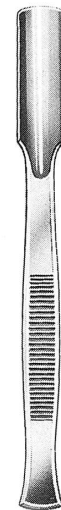

13.5 cm

PV. 25.04	4 mm
PV. 25.06	6 mm
PV. 25.08	8 mm
PV. 25.10	10 mm
PV. 25.12	12 mm
PV. 25.14	14 mm
PV. 25.16	16 mm

Chisels, Gouges and Osteotomes

Meißel und Osteotome

Cinceles, Gubias y Osteótomos

Ciseaux-Burins, Gouges et Ostéotomes



- HIBBS
24 cm
- PV. 30.06 6 mm
 - PV. 30.13 13 mm
 - PV. 30.19 19 mm
 - PV. 30.25 25 mm
 - PV. 30.32 32 mm
 - PV. 30.40 40 mm



- HIBBS
24 cm
- PV. 31.06 6 mm
 - PV. 31.13 13 mm
 - PV. 31.19 19 mm
 - PV. 31.25 25 mm
 - PV. 31.32 32 mm
 - PV. 31.40 40 mm



- HIBBS
24 cm
- PV. 32.06 6 mm
 - PV. 32.13 13 mm
 - PV. 32.19 19 mm
 - PV. 32.25 25 mm
 - PV. 32.32 32 mm
 - PV. 32.40 40 mm



- HIBBS
24 cm
- PV. 33.06 6 mm
 - PV. 33.13 13 mm
 - PV. 33.19 19 mm
 - PV. 33.25 25 mm
 - PV. 33.32 32 mm
 - PV. 33.40 40 mm



- HIBBS
24 cm
- PV. 33.56 6 mm
 - PV. 33.53 13 mm
 - PV. 33.59 19 mm
 - PV. 33.65 25 mm
 - PV. 33.72 32 mm
 - PV. 33.80 40 mm



LUCAS
16 cm

- PV. 35.04 4 mm
- PV. 35.06 6 mm
- PV. 35.08 8 mm
- PV. 35.10 10 mm



LUCAS
16 cm

- PV. 35.34 4 mm
- PV. 35.36 6 mm
- PV. 35.38 8 mm
- PV. 35.40 10 mm

Gouges
 Hohlmeißel
 Gubias
 Gouges

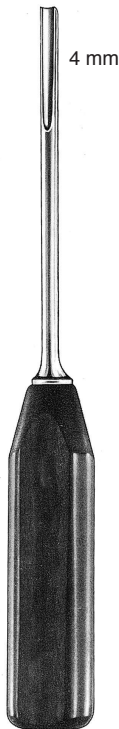

COBB
 PV. 36.91 28 cm

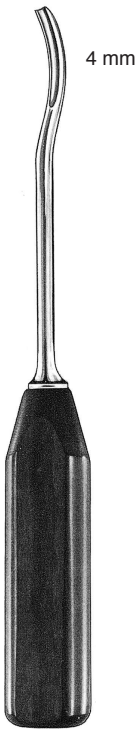

COBB
 PV. 36.92 28 cm

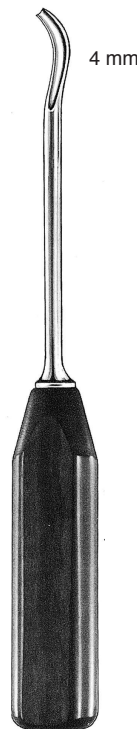

COBB
 PV. 36.93 28 cm



COBB
 PV. 36.94 28 cm



LEXER
 25 cm
 PV. 36.55 5 mm
 PV. 36.60 10 mm
 PV. 36.65 15 mm



LEXER
 25 cm
 PV. 36.75 5 mm
 PV. 36.80 10 mm
 PV. 36.85 15 mm

Chisels & Gouges

Flach- & Hohlmeißel

Cinceles y Gubias

Ciseaux-burins et Gouges

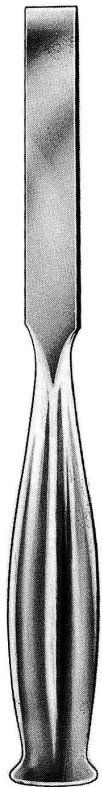

PV. 38.06 6 mm
 PV. 38.09 9 mm
 PV. 38.12 12 mm
 PV. 38.14 14 mm
 PV. 38.15 15 mm
 PV. 38.20 20 mm
 PV. 38.25 25 mm
 PV. 38.30 30 mm



PV. 38.56 6 mm
 PV. 38.59 9 mm
 PV. 38.62 12 mm
 PV. 38.64 14 mm
 PV. 38.65 15 mm
 PV. 38.70 20 mm
 PV. 38.75 25 mm
 PV. 38.82 30 mm

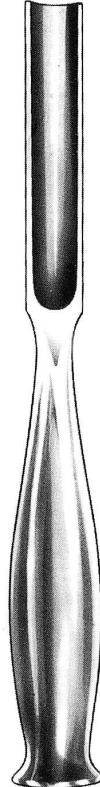

PV. 40.06 6 mm
 PV. 40.09 9 mm
 PV. 40.12 12 mm
 PV. 40.15 15 mm
 PV. 40.16 16 mm
 PV. 40.17 17 mm
 PV. 40.20 20 mm
 PV. 40.25 25 mm
 PV. 40.30 30 mm

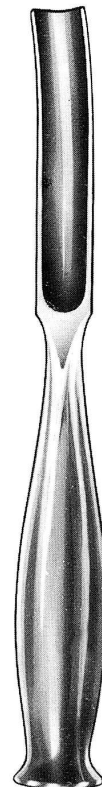

PV. 40.56 6 mm
 PV. 40.59 9 mm
 PV. 40.62 12 mm
 PV. 40.64 14 mm
 PV. 40.65 15 mm
 PV. 40.66 16 mm
 PV. 40.70 20 mm
 PV. 40.75 25 mm
 PV. 40.80 30 mm

SMITH-PETERSEN
20 cm



LAMBOTTE
24 cm

PV. 39.04 4 mm
 PV. 39.06 6 mm
 PV. 39.08 8 mm
 PV. 39.10 10 mm
 PV. 39.12 12 mm
 PV. 39.15 15 mm
 PV. 39.20 20 mm
 PV. 39.25 25 mm
 PV. 39.30 30 mm
 PV. 39.38 38 mm
 PV. 39.40 40 mm
 PV. 39.44 44 mm
 PV. 39.50 50 mm

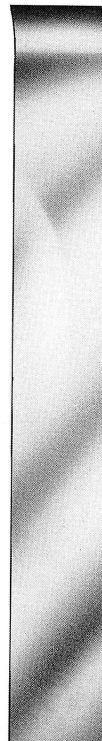

LAMBOTTE
24 cm

PV. 39.54 4 mm
 PV. 39.56 6 mm
 PV. 39.58 8 mm
 PV. 39.60 10 mm
 PV. 39.62 12 mm
 PV. 39.65 15 mm
 PV. 39.70 20 mm
 PV. 39.75 25 mm
 PV. 39.80 30 mm
 PV. 39.88 38 mm
 PV. 39.90 40 mm
 PV. 39.94 44 mm
 PV. 39.99 50 mm

Chisels & Gouges

Flach- & Hohlmeißel

Cinceles y Gubias

Ciseaux-burins et Gouges

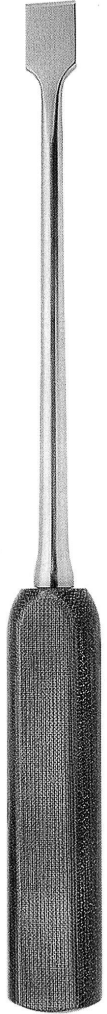

DAHMEN
30 cm

4 mm
5 mm
6 mm
8 mm
10 mm
12 mm
15 mm
20 mm
22 mm
25 mm



PV. 45.04
PV. 45.05
PV. 45.06
PV. 45.08
PV. 45.10
PV. 45.12
PV. 45.15
PV. 45.20
PV. 45.22
PV. 45.25

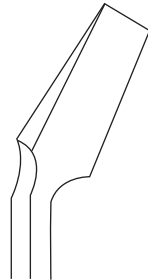

PV. 46.04
PV. 46.05
PV. 46.06
PV. 46.08
PV. 46.10
PV. 46.12
PV. 46.15
PV. 46.20
PV. 46.22
PV. 46.25



PV. 47.04
PV. 47.05
PV. 47.06
PV. 47.08
PV. 47.10
PV. 47.12
PV. 47.15
PV. 47.20
PV. 47.22
PV. 47.25

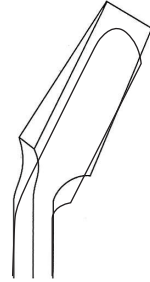

PV. 48.04
PV. 48.05
PV. 48.06
PV. 48.08
PV. 48.10
PV. 48.12
PV. 48.15
PV. 48.20
PV. 48.22
PV. 48.25

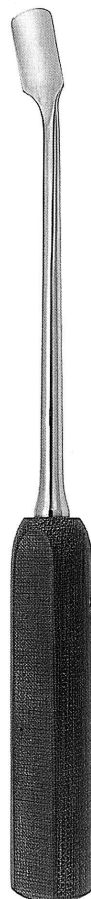
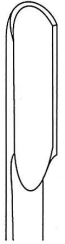

LEXER
27.5 cm

PV. 50.10 10 mm
PV. 50.15 15 mm

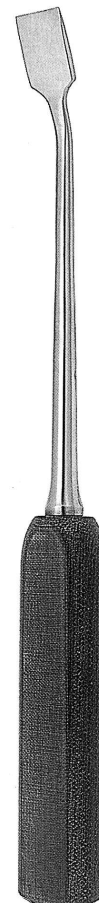

LEXER
27.5 cm

PV. 52.10 10 mm
PV. 52.15 15 mm

Chisels, Gouges and Osteotomes

Meißel und Osteotome

Cinceles y Gubias

Ciseaux-Burins et Ostéotomes

Meniscotomy knives

Meniskotome

Bisturies para meniscos

Bistouris à ménisques



MINI-LEXER
18 cm

PV. 54.04	4 mm
PV. 54.06	6 mm
PV. 54.08	8 mm
PV. 54.10	10 mm
PV. 54.12	12 mm
PV. 54.15	15 mm
PV. 54.20	20 mm



MINI-LEXER
18 cm

PV. 56.04	4 mm
PV. 56.06	6 mm
PV. 56.08	8 mm
PV. 56.10	10 mm
PV. 56.12	12 mm
PV. 56.15	15 mm
PV. 56.20	20 mm



LEXER
22 cm

PV. 58.07	7 mm
PV. 58.10	10 mm
PV. 58.15	15 mm
PV. 58.20	20 mm
PV. 58.25	25 mm
PV. 58.30	30 mm



LEXER
22 cm

PV. 60.07	7 mm
PV. 60.10	10 mm
PV. 60.15	15 mm
PV. 60.20	20 mm
PV. 60.25	25 mm
PV. 60.30	30 mm

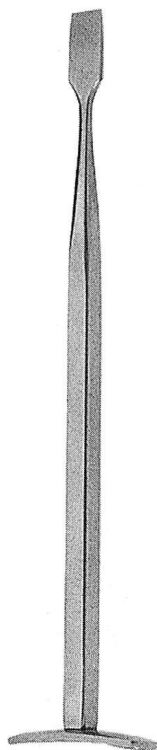

SMILLIE
17 cm

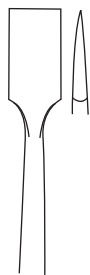

PV. 62.01

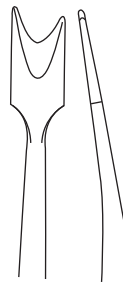

PV. 62.02

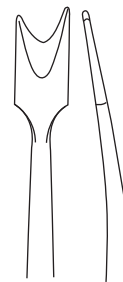

PV. 62.03

Bone curettes

Scharfe Löffel

Cucharillas cortantes

Curettes tranchantes

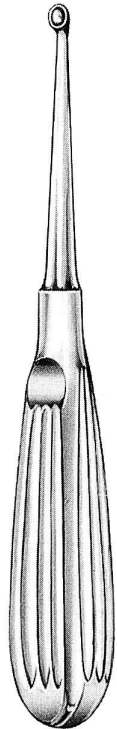

BRUNS
17 cm

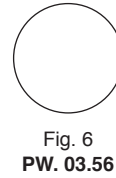
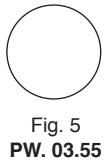
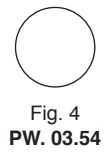
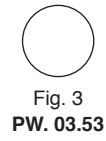
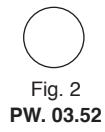
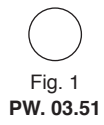
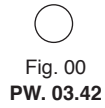
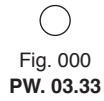

BRUNS
23 cm

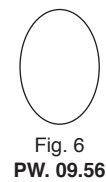
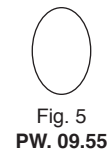
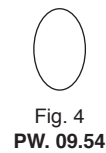
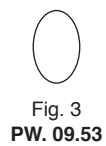
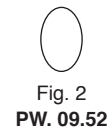
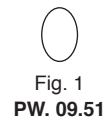
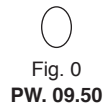
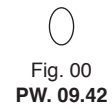
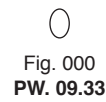
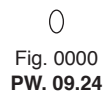

Bone curettes

Scharfe Löffel

Cucharillas cortantes

Curettes tranchantes

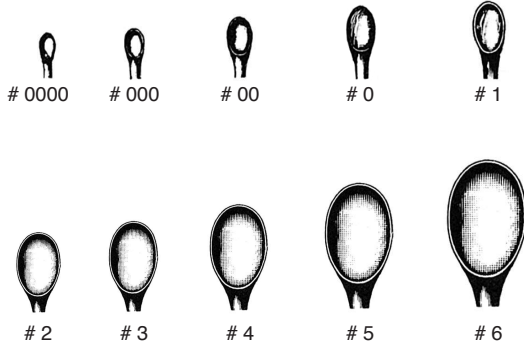
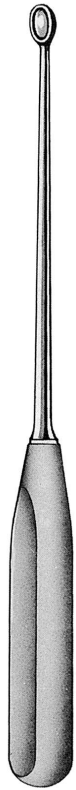

PW. 10.24 # 0000
 PW. 10.33 # 000
 PW. 10.42 # 00
 PW. 10.50 # 0
 PW. 10.51 # 1
 PW. 10.52 # 2
 PW. 10.53 # 3
 PW. 10.54 # 4
 PW. 10.55 # 5
 PW. 10.56 # 6

BRUNS
 (VOLKMANN)
 27 cm
 Silver Handle

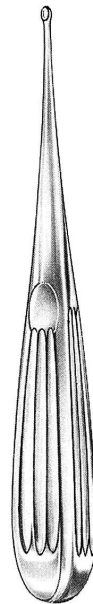

SPRATT
 17 cm

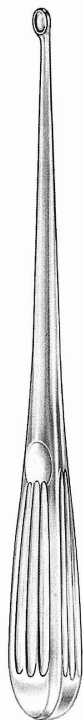
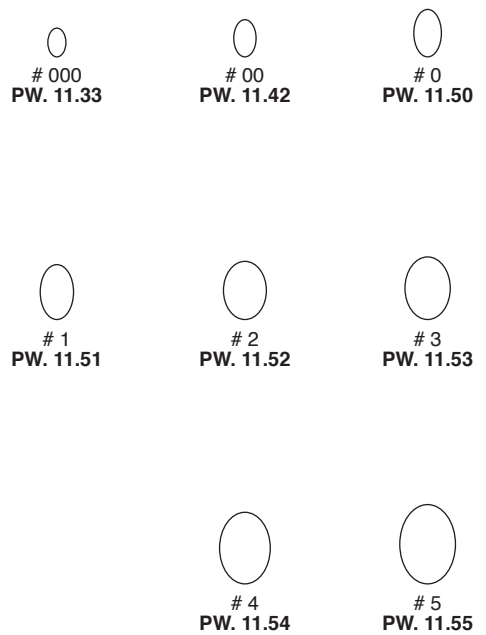

PW. 11.60 - PW. 11.68

Fig. # 000
 PW. 11.60
 PW. 11.70

Fig. # 00
 PW. 11.61
 PW. 11.71

Fig. # 0
 PW. 11.62
 PW. 11.72

Fig. # 1
 PW. 11.63
 PW. 11.73

Fig. # 2
 PW. 11.64
 PW. 11.74

Fig. # 3
 PW. 11.65
 PW. 11.75

Fig. # 4
 PW. 11.66
 PW. 11.76

Fig. # 5
 PW. 11.67
 PW. 11.77

Fig. # 6
 PW. 11.68
 PW. 11.78

HIBBS SPRATT
 SPINAL FUSION
 25.5 cm

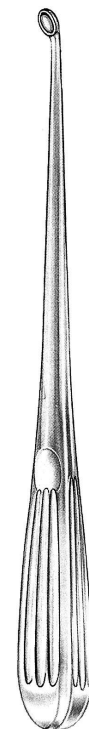

PW. 11.70 - PW. 11.78

Bone curettes

Scharfe Löffel

Cucharillas cortantes

Curettes tranchantes



HALLE
21 cm



Fig. # 1 - 4 mm
PW. 13.51



Fig. # 2 - 5 mm
PW. 13.52



Fig. # 3 - 6 mm
PW. 13.53

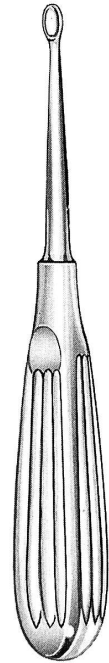

VOLKMANN
17 cm



Fig. # 0000
PW. 14.24



Fig. # 000
PW. 14.33



Fig. # 00
PW. 14.42



Fig. # 0
PW. 14.50



Fig. # 1
PW. 14.51



Fig. # 2
PW. 14.52



Fig. # 3
PW. 14.53



Fig. # 4
PW. 14.54

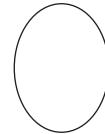

Fig. # 5
PW. 14.55

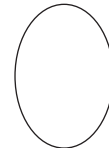
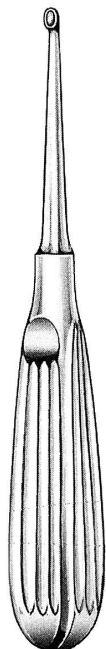

Fig. # 6
PW. 14.56



SCHEDE
17 cm



Fig. # 000
PW. 15.33



Fig. # 00
PW. 15.42



Fig. # 0
PW. 15.50



Fig. # 1
PW. 15.51



Fig. # 2
PW. 15.52



Fig. # 3
PW. 15.53



Fig. # 4
PW. 15.54

Bone curettes

Scharfe Löffel

Cucharillas cortantes

Curettes tranchantes

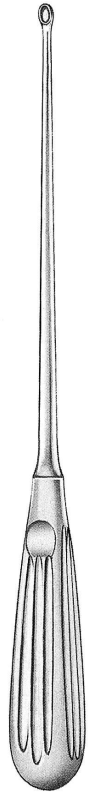

PW. 16.24 - PW. 16.56

Fig. # 0000
PW. 16.24
PW. 17.24

Fig. # 000
PW. 16.33
PW. 17.33

Fig. # 00
PW. 16.42
PW. 17.42

Fig. # 0
PW. 16.50
PW. 17.50

Fig. # 1
PW. 16.51
PW. 17.51

Fig. # 2
PW. 16.52
PW. 17.52

Fig. # 3
PW. 16.53
PW. 17.53

Fig. # 4
PW. 16.54
PW. 17.54

Fig. # 5
PW. 16.55
PW. 17.55

Fig. # 6
PW. 16.56
PW. 17.56

BRUNS-VOLKMANN
23 cm

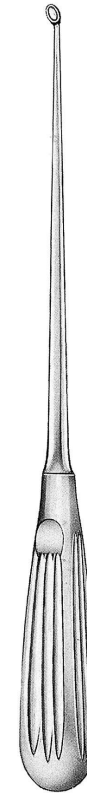

PW. 17.24 - PW. 17.56



MARTINI
13.5 cm

PW. 18.10

PW. 18.11

PW. 18.12

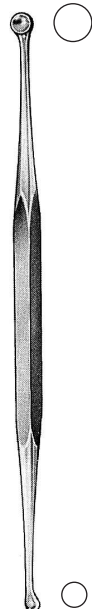

JANSEN
PW. 19.62
17 cm

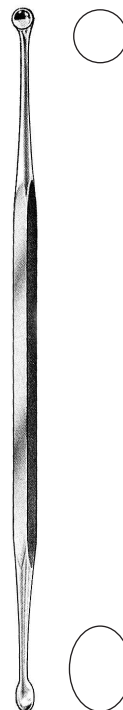

PW. 20.96
21 cm



WILLIGER
13.5 cm

PW. 21.10

PW. 21.11

PW. 21.12

Bone curettes

Scharfe Löffel

Cucharillas cortantes

Curettes tranchantes

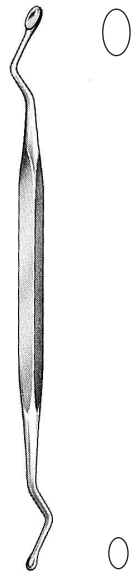

JANSEN
PW. 23.72
17 cm

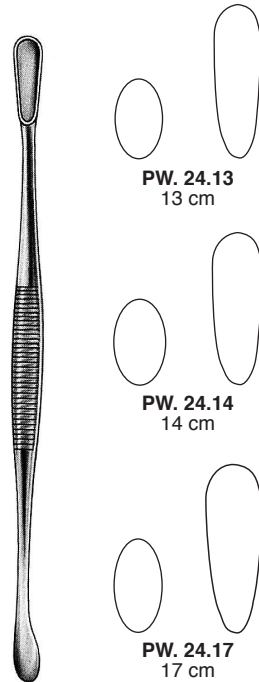

VOLKMANN



VOLKMANN
22 cm

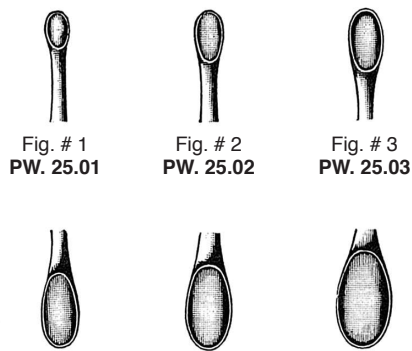
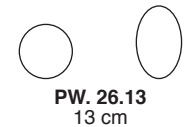

Fig. # 1
PW. 25.01

Fig. # 2
PW. 25.02

Fig. # 3
PW. 25.03



PW. 26.13
13 cm

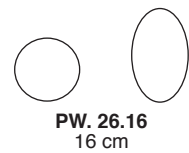

PW. 26.16
16 cm

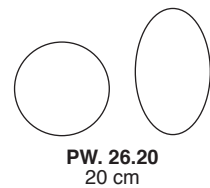

PW. 26.20
20 cm

VOLKMANN

Bone rongeurs
 Hohlmeißelzangen
 Pinzas Gubias
 Pincas gouges

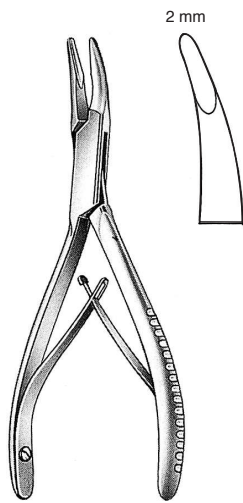

MINI-FRIEDMAN
 PX. 01.12
 12 cm

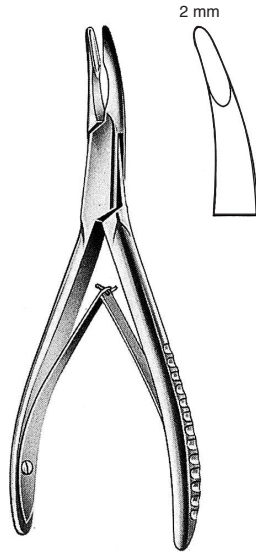

FRIEDMAN
 PX. 01.14
 14 cm

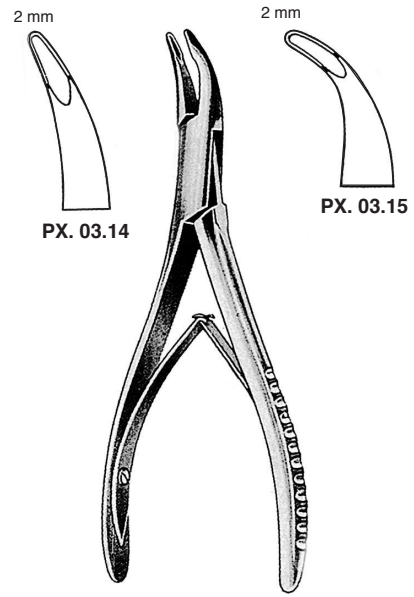

PX. 03.14

PX. 03.15

14 cm

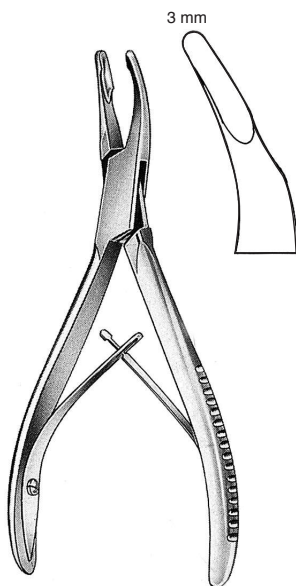

UNIVERSAL
 PX. 03.84
 13 cm

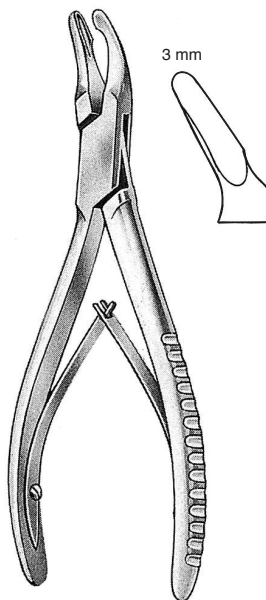

MEAD
 PX. 04.14
 14 cm

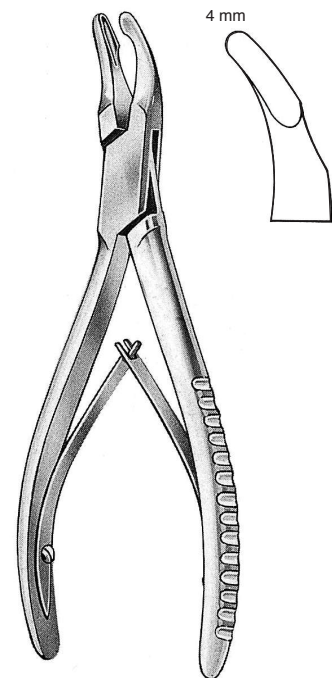

MEAD
 PX. 04.17
 17 cm

Bone rongeurs
 Hohlmeißelzangen
 Pinzas Gubias
 Pincas gouges

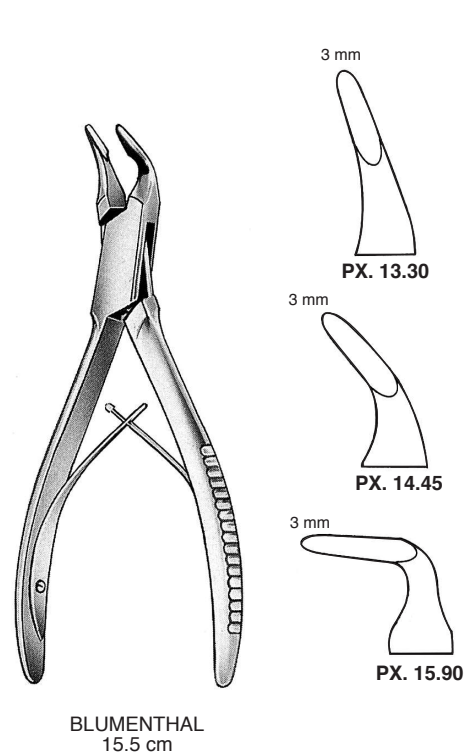
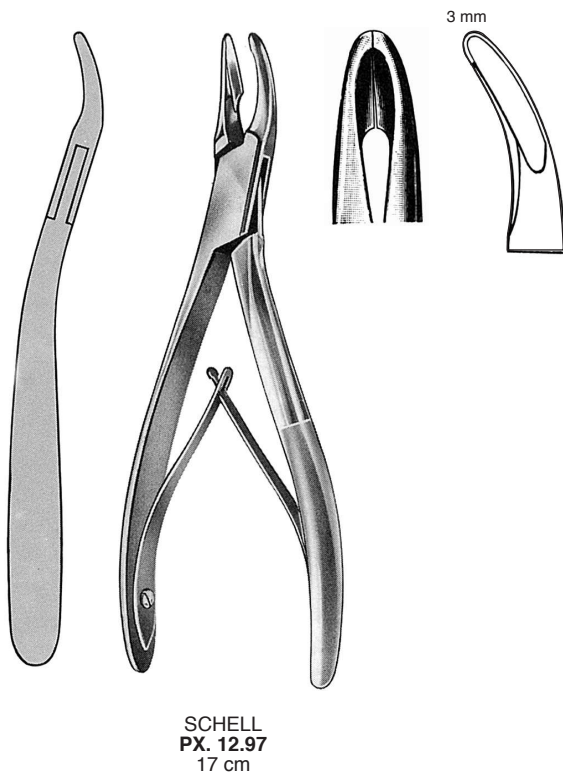
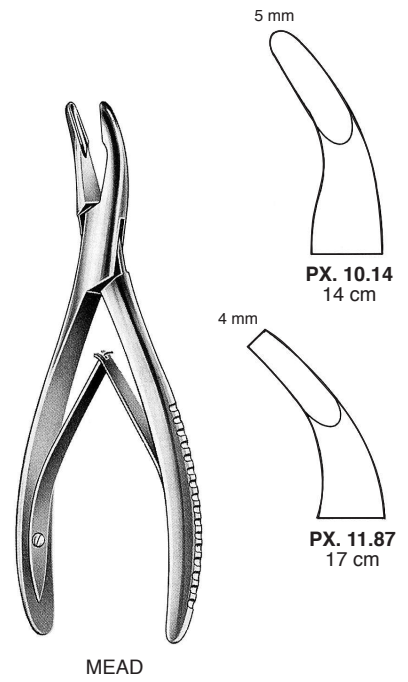
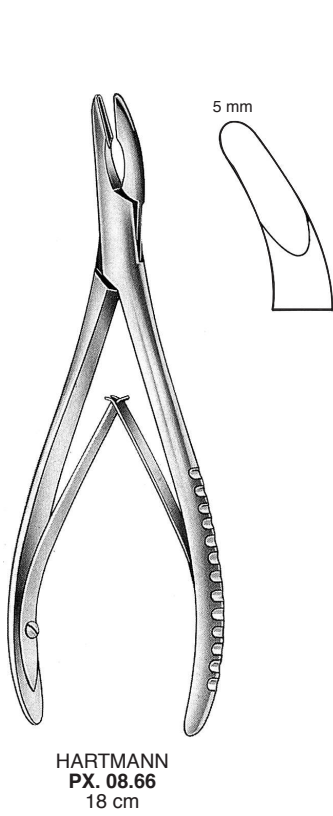

Bone rongeurs
 Hohlmeißelzangen
 Pinzas Gubias
 Pincas gouges

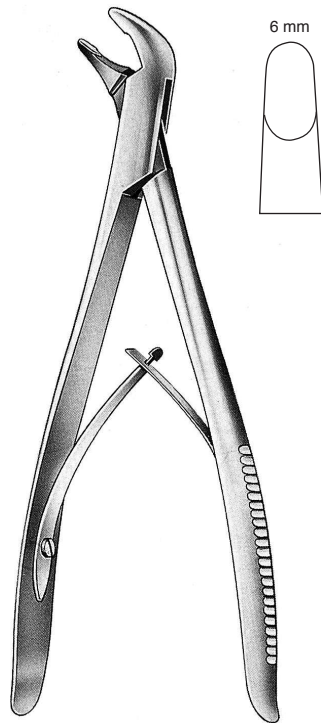

BACON
PX. 18.70
 20 cm

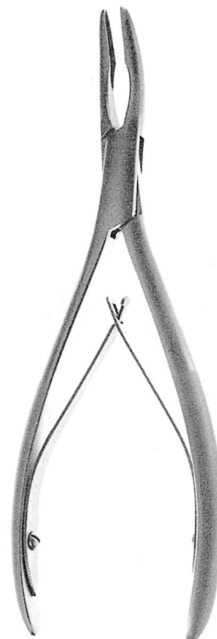

BEYER
 17 cm

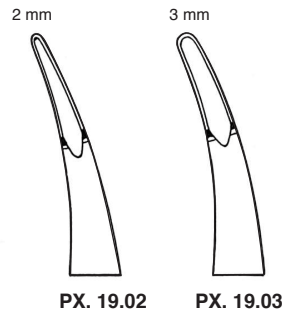

PX. 19.02

PX. 19.03

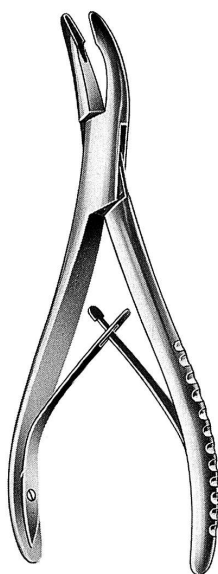

LUER
 15 cm



PX. 20.55

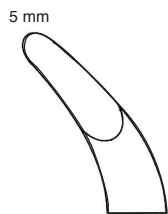

PX. 20.65

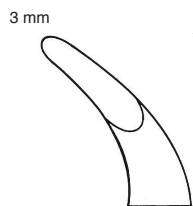

PX. 20.75

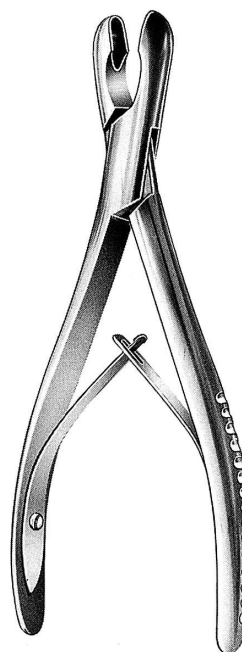

LUER
 18 cm

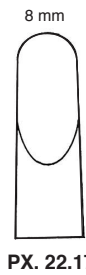

PX. 22.17



PX. 22.18

Bone rongeurs
 Hohlmeißelzangen
 Pinzas Gubias
 Pincas gouges

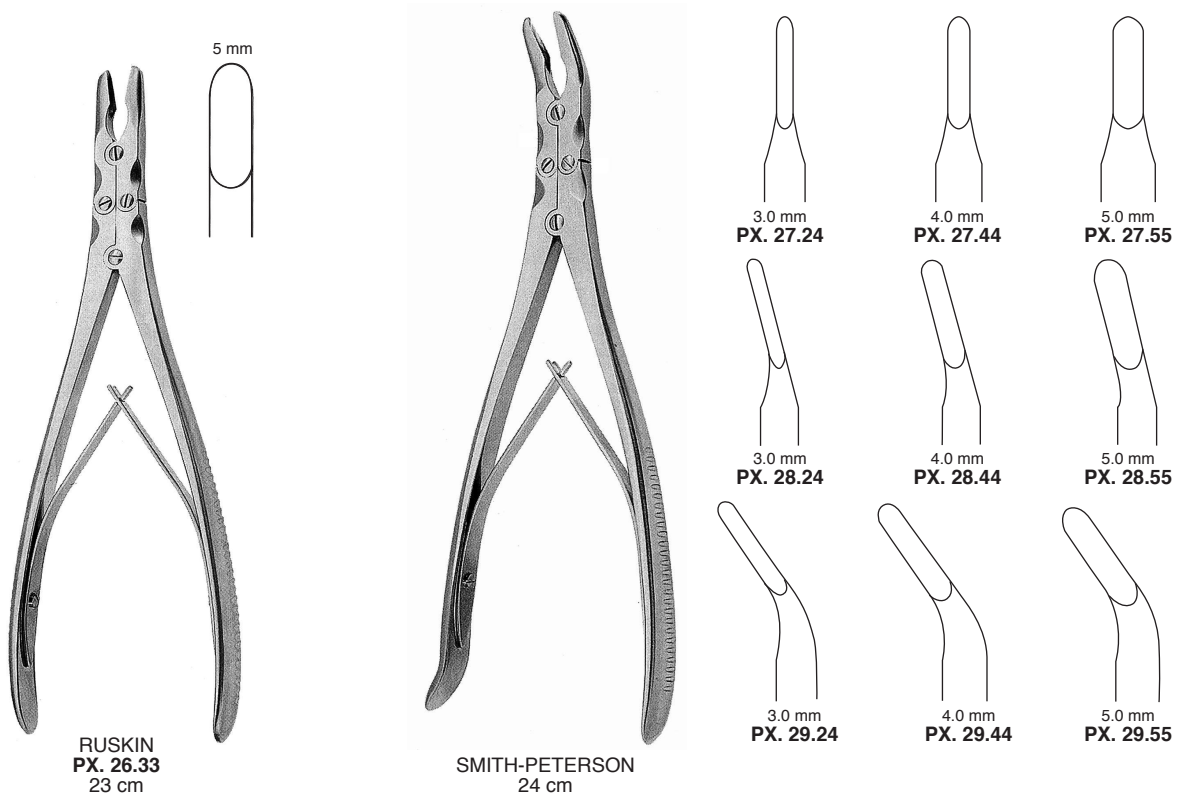
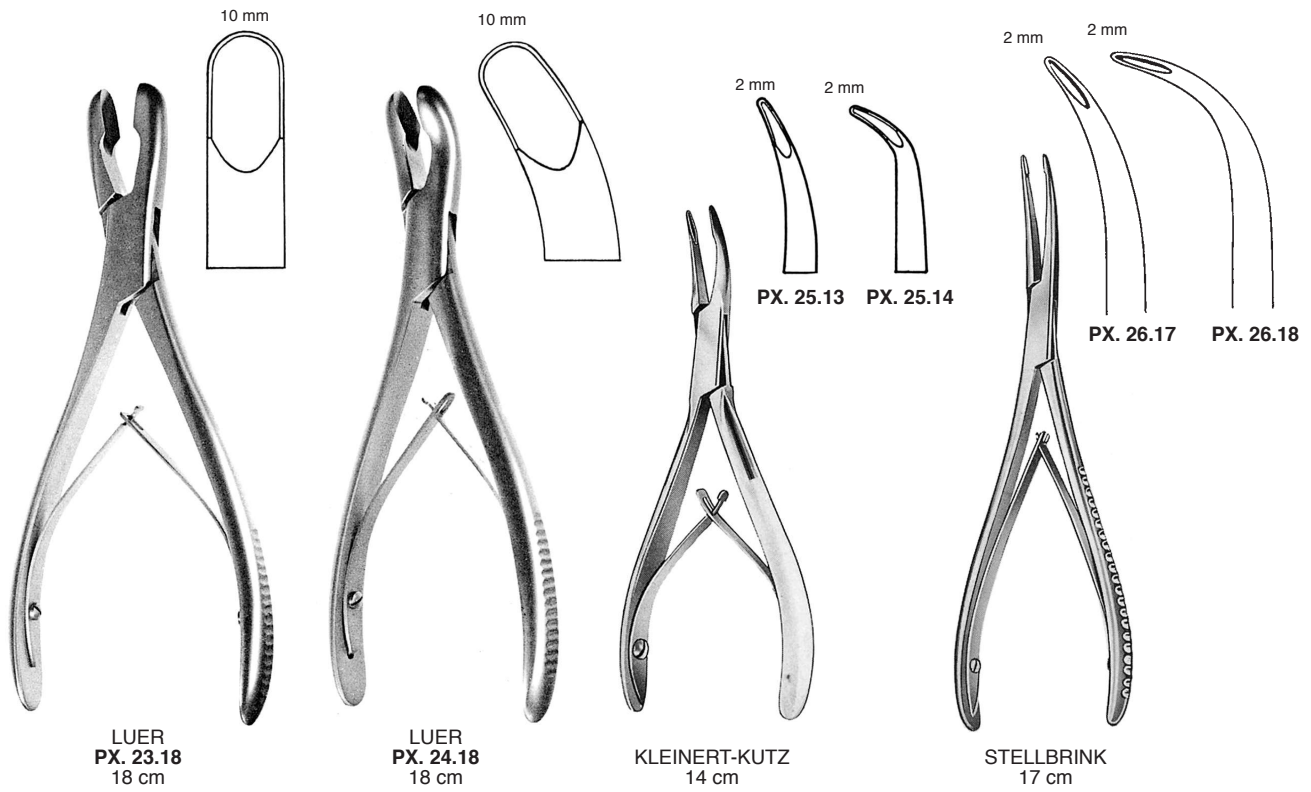

Bone rongeurs
 Hohlmeißelzangen
 Pinzas Gubias
 Pincas gouges

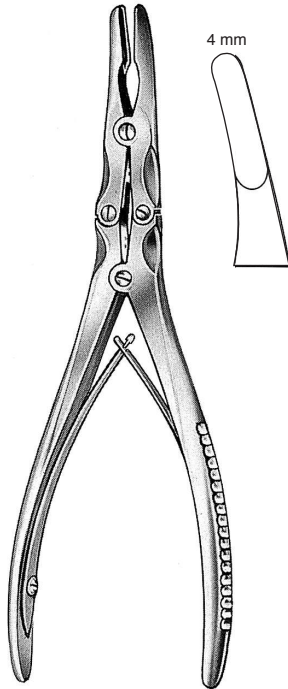

ZAUFAL-JANSEN
PX. 30.18
 18 cm

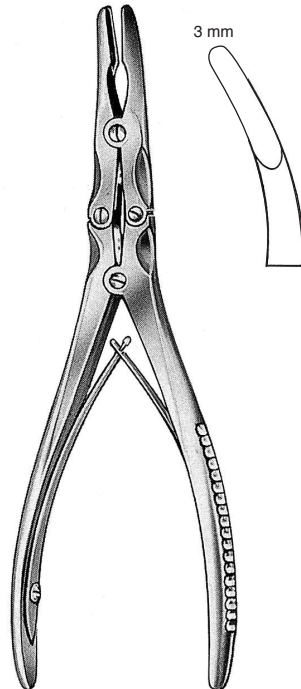

BEYER
PX. 31.18
 18 cm

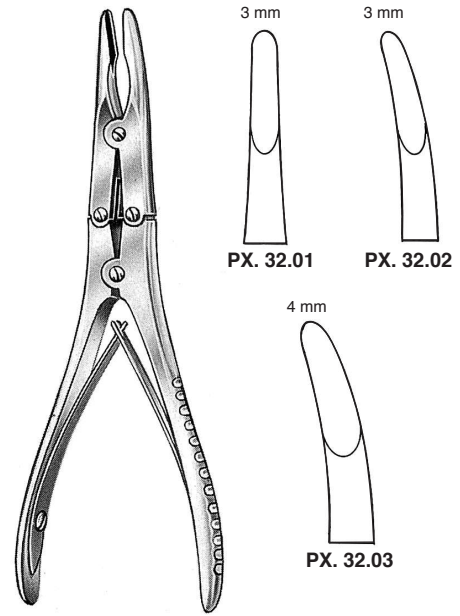

BÖHLER
 15 cm

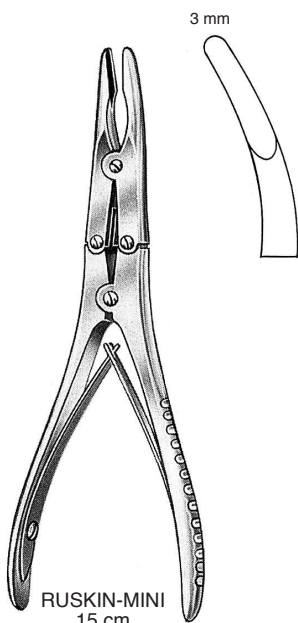

RUSKIN-MINI
 15 cm

<i>Straight</i>		<i>Curved</i>
PX. 32.15	2 mm	PX. 33.15
PX. 32.17	3 mm	PX. 33.17

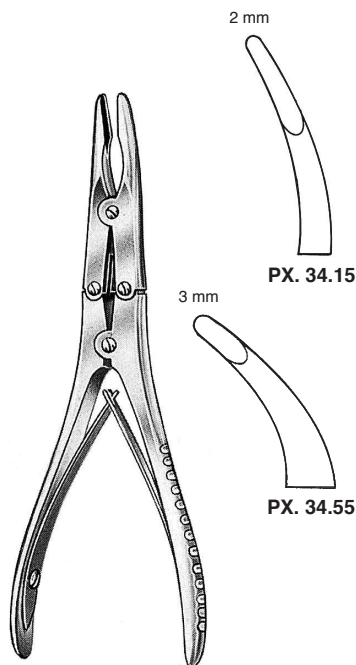

KLEINERT-KUTZ
 15 cm

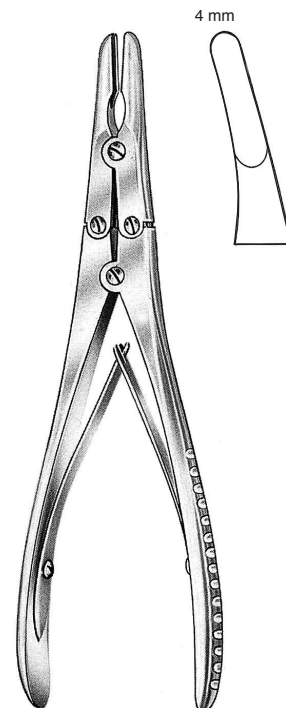

RUSKIN
PX. 34.18
 18 cm

Bone rongeurs
 Hohlmeißelzangen
 Pinzas Gubias
 Pincas gouges

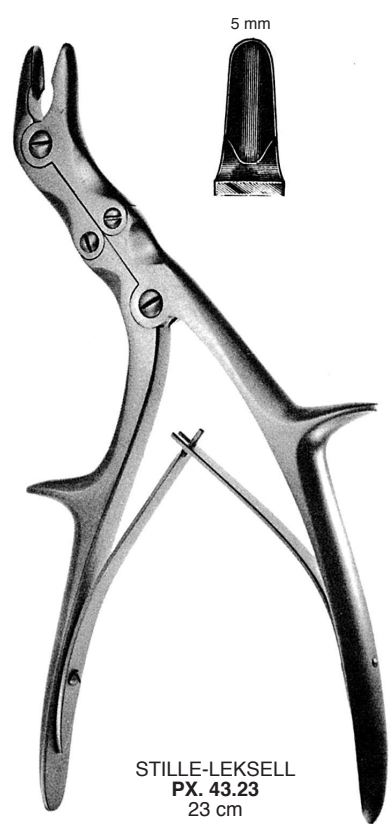
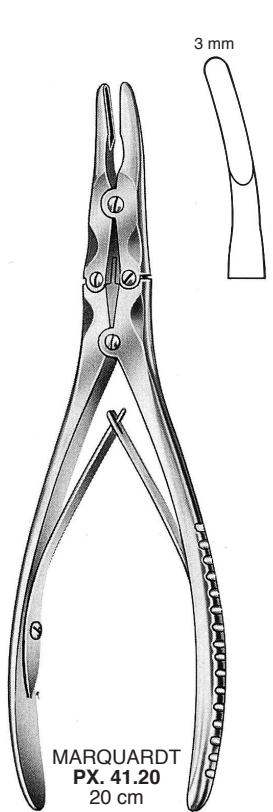
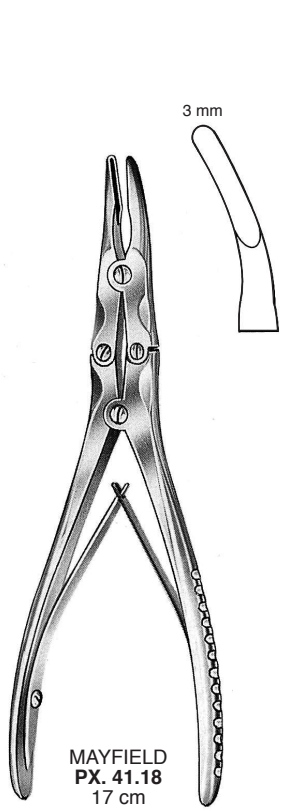
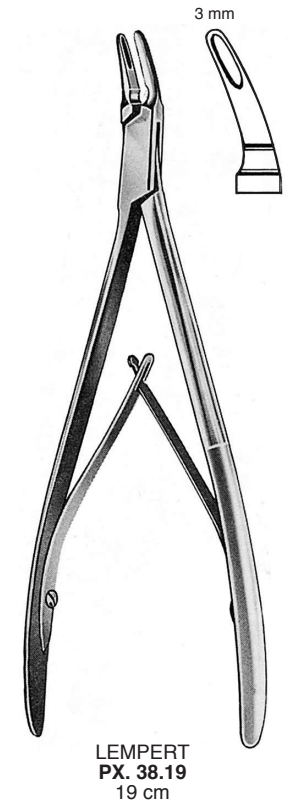
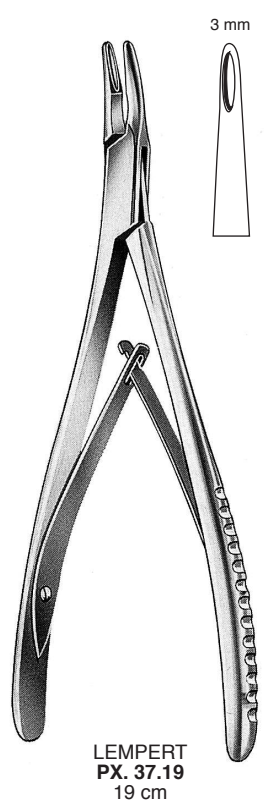
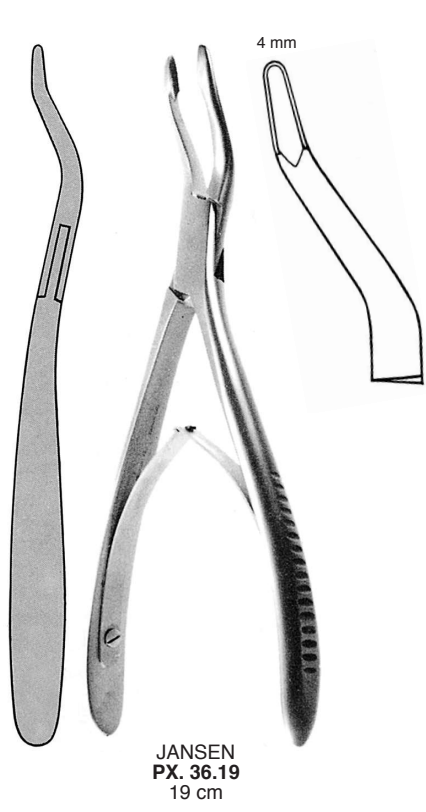

Bone rongeurs
 Hohlmeißelzangen
 Pinzas Gubias
 Pincas gouges

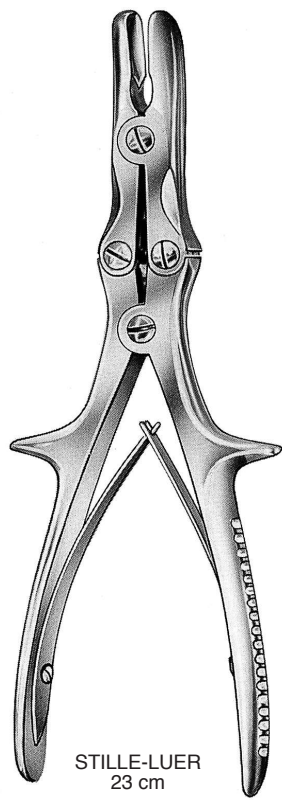

PX. 44.23



PX. 45.23

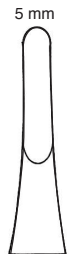
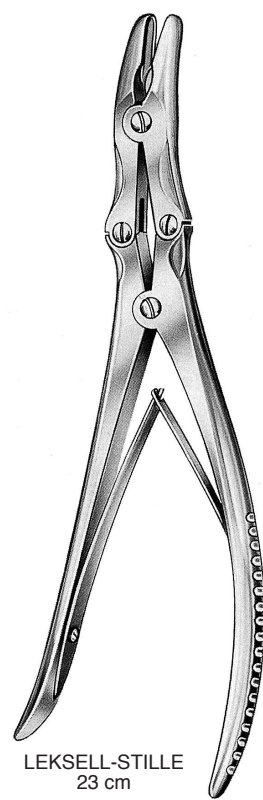
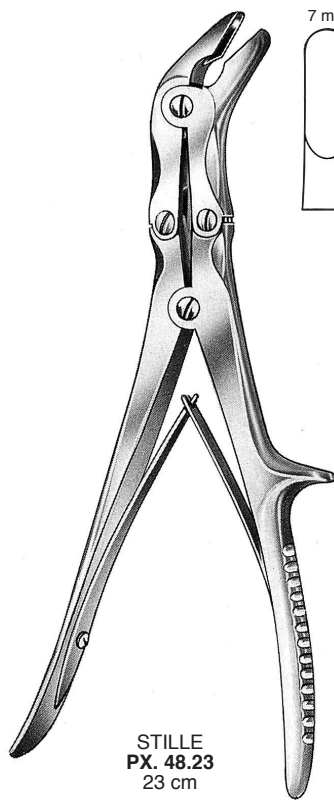

PX. 49.05



PX. 49.08

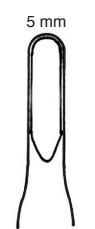
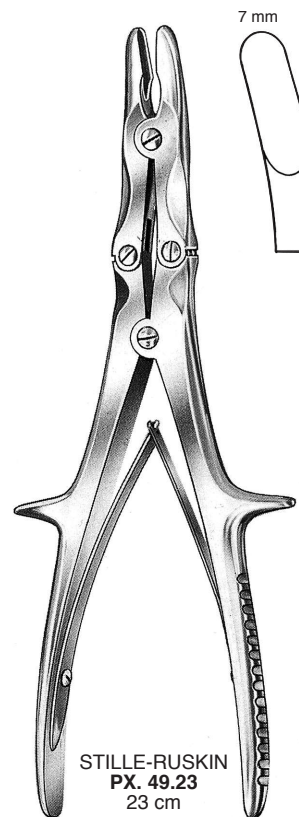

PX. 50.05



PX. 50.08

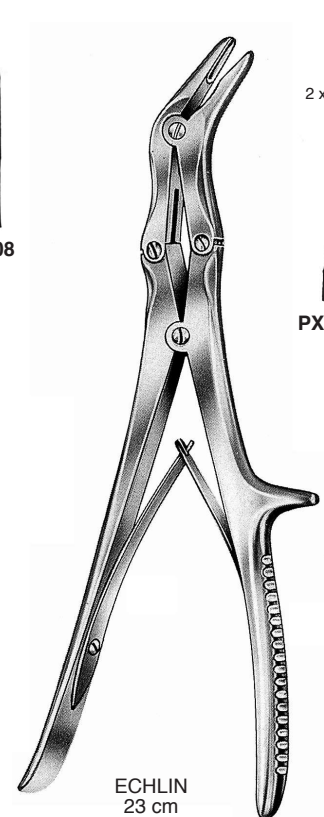

PX. 51.02



PX. 51.03

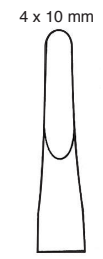

PX. 51.04

Bone rongeurs
 Hohlmeißelzangen
 Pinzas Gubias
 Pincas gouges

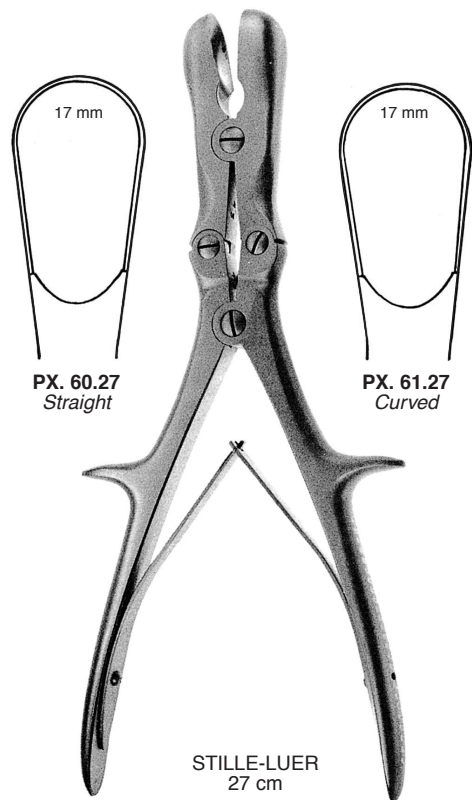
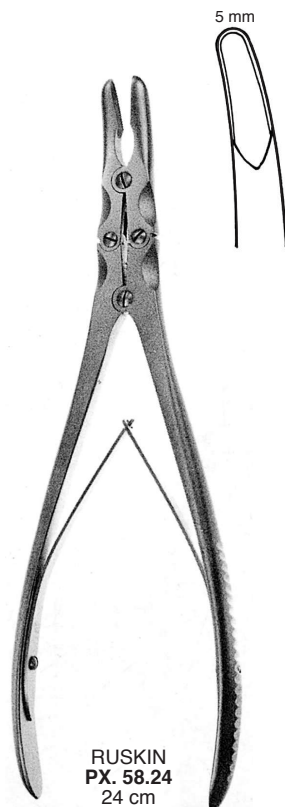
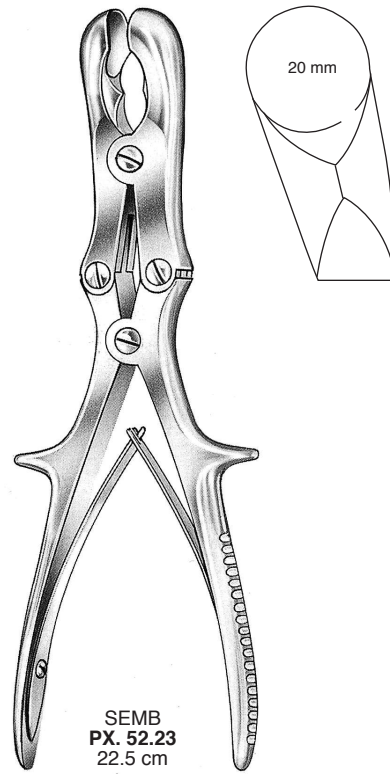

Hand bone drills

Handbohrapparate

Perforadores de mano para huesos

Perforateur à main

Finger ring saws and nail instruments

Fingerringsägen und Nagelzange

Sierras para abrir anillos y pinza para uñas

Scies pour bagues et pince à ongle

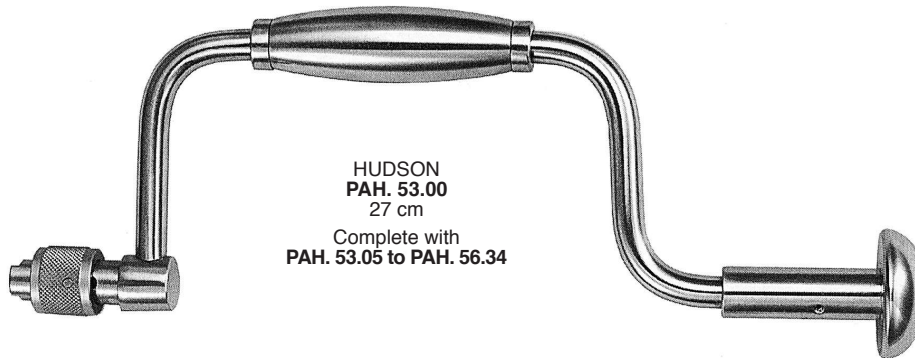

HUDSON
PAH. 53.00
27 cm
Complete with
PAH. 53.05 to PAH. 56.34

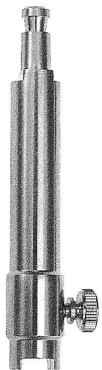

PAH. 53.05
10 cm



PAH. 54.00
ø 9 mm, 10 cm



PAH. 54.14
ø 14 mm, 10 cm



PAH. 55.16
ø 16 mm, 10 cm



PAH. 55.22
ø 22 mm, 10 cm



CUSHING
PAH. 56.34
ø 14 mm, 10 cm



WALTON
PAE. 03.00
16 cm

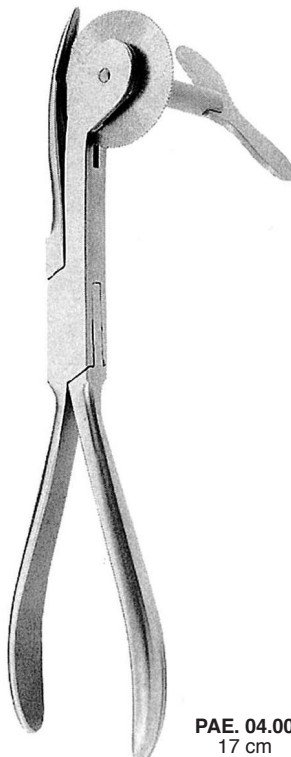

PAE. 04.00
17 cm

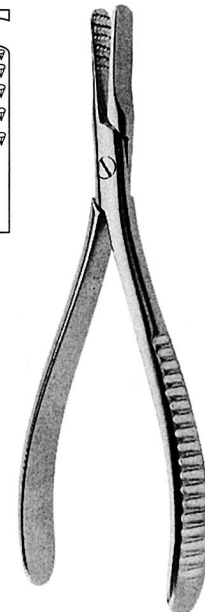

RADOLF
PAE. 15.15
13.5 cm

INDEX

ADSON	Dressing & Tissue Forceps	7	HALSTEAD-MOSQUITO	Hemostatic Forceps	8
ADSON	Dressing & Tissue Forceps, TC	7	HARTMANN	Bone Rongeur	61
ADSON	Elevators	27	HENNIG	Plaster Cast Breaker	21
ADSON	Haemostatic Forceps	11	HIBBS	Chisels & Gouges	50
ADSON	Laminectomy Retractors	16	HIBBS-SPRATT	Bone Curettes	56
ALDERDYCE	Elevators	29	HOEN	Elevators	26
ALEXANDER	Chisels & Gouges	49	HOHMANN	Bone Levers	31,32
BACKHAUS	Towel Clamps	12	HOKE	Chisels & Osteotomes	48
BACON	Bone Rongeur	62	HOPKINS	Plaster of Paris Knives	21
BECKMANN-ADSON	Laminectomy Retractors	16	HORSLEY-STILLE	Bone Cutting Forceps	36
BECKMANN-EATON	Laminectomy Retractors	16	HUDSON	Hand Drills	68
BEESON	Plaster Spreader	21	IRIS	Delicate Scissors	3
BERGMANN	Bandage Scissors	20	IRIS	Delicate Scissors, TC	4
BERGMANN	Mallets	24	JANSEN	Bone Curettes	58,59
BEYER	Bone Rongeur	62,64	JANSEN	Bone Rongeur	65
BLOUNT	Bone Lever	32	JANSEN	Retractors	16
BLOUNT	Knee Retractors	33	JOSEPH	Periosteal Elevators	26
BLUMENTHAL	Bone Rongeur	61	KERN	Bone Holding Forceps	41
BOHLER	Bone Rongeur	64	KIRK	Mallet	22
BOHLER	Traction Bow	44	KIRMISSION	Periosteal Raspatory	28
BRUNS	Bandage Scissors	20	KLEINERT-KUTZ	Bone Cutting Forceps	35
BRUNS	Bone Curettes	55	KLEINERT-KUTZ	Bone Rongeur	63,64
BRUNS (VOLKMANN)	Bone Curettes	56,58	KOCHER	Hemostatic Forceps	11
CHARRIERE	Amputation Saw	44	KONRICH	Sterilizing Dressing Drums	17
CHEATLE	Sterilizing Forceps	17	LAMBOTTE	Bone Holding Forceps	41,42
CHERON	Dressing Forceps	8	LAMBOTTE	Chisels	52
CLEVELAND	Bone Cutting Forceps	34	LAMBOTTE	Raspatories	29
COBB	Elevators	29	LANE	Bone Holding Forceps	41
COBB	Gouges	51	LANGE-HOHMANN	Bone Levers	32
COLLIN	Mallet	23	LANGENBECK	Amputation Saw	44
COTTLE	Mallet	24	LANGENBECK	Bone Holding Forceps	39
COTTLE-KAZANJIAN	Bone Cutting Forceps	34	LANGENBECK	Elevators & Raspatories	29,30
CRILE-WOOD	Needle Holder	13	LANGENBECK	Raspatories	29
CRILE-WOOD	Needle Holder, TC	13	LANGENBECK	Retractors	15
CUSHING	Perforator	68	LEKSELL	Bone Rongeur	66
DAHMEN	Chisel	53	LEKSELL-STILLE	Bone Rongeur	66
DINGMAN	Bone Holding Forceps	38	LEMPERT	Bone Rongeur	65
DOYEN	Mallets	24	LEMPERT	Periosteal Elevators	27
DOYEN	Raspatories	30	LEWIN	Bone Holding Forceps	39
ECHLIN	Bone Rongeur	66	LEXER	Chisels & Gouges	51,53,54
ENGEL	Plaster of Paris Saw	21	LISTER	Bandage Scissors	20
ESMARCH	Bandage Scissors	20	LISTER	Bandage Scissors, TC	20
ESMARCH	Plaster of Paris Knives	21	LISTON	Bone Cutting Forceps	34,35
FARABEUF	Bone Holding Forceps	41	LISTON-KEY	Bone Cutting Forceps	36
FARABEUF	Raspatories	28	LISTON-MINI	Bone Cutting Forceps	35
FARABEUF	Retractor	15	LISTON-STILLE	Bone Cutting Forceps	35
FARABEUF-BABY	Retractor	15	LITTAUER-LISTON	Bone Cutting Forceps	34
FARABEUF-LAMBOTTE	Bone Holding Forceps	41	LOUTE	Wire Twister	45
FERGUSSON	Bone Holding Forceps	39	LOWMAN	Bone Holding Clamps	37
FOERSTER	Sponge Holding Forceps	8	LUCAE	Mallets	23
FREER	Elevators	29	LUCAS	Chisels & Osteotomes	50
FRIEDMAN	Bone Rongeur	60	LUER	Bone Rongeur	62,63
FRYKHOLM	Bone Rongeur	67	MARQUARDT	Bone Rongeur	65
GEMINI	Dissecting & Ligature Forceps	12	MARTIN	Bone Holding Forceps	39
GERSTER-LOWMANN	Bone Holding Forceps	37	MARTINI	Bone Curettes	58
GERZOG	Mallet	22	MATHIEU	Needle Holder, TC	14
GIGLI	Wire Saws & Handle	44	MATHIEU-KOCHER	Needle Holder, TC	14
HAJEK	Mallet	23	MAYFIELD	Bone Rongeur	65
HALLE	Bone Curettes	57	MAYO	Operating & Dissecting Scissors	3
HALSTEAD-ADSON	Hemostatic Forceps	11	MAYO	Operating & Dissecting Scissors, TC	4

INDEX

MAYO	Safety Pin	17	STILLE	Bone Rongeurs	66
MAYO-HARRINGTON	Operating & Dissecting Scissors	3	STILLE	Chisels & Gouges	48,49
MAYO-HARRINGTON	Operating & Dissecting Scissors, TC	4	STILLE	Plaster Shears	21
MAYO-HEGAR	Needle Holders	13	STILLE-LEKSELL	Bone Rongeurs	65
MAYO-HEGAR	Needle Holders, TC	13	STILLE-LUER	Bone Rongeurs	66,67
MAYO-STILLE	Operating & Dissecting Scissors	3	STILLE-RUSKIN	Bone Rongeurs	66
MAYO-STILLE	Operating & Dissecting Scissors, TC	4	TAYLOR	Bone Levers	32
MCDONALD	Dissector	26	THIESS	Mallet	23
MCINDOE	Bone Cutting Forceps	35	TRAUTMANN	Chisels & Gouges	48
MEAD	Bone Rongeur	60,61	ULRICH	Bone Holding Forceps	40
MEAD	Mallets	22	UNIVERSAL	Bandage & Wire Cutting Scissors	20
METZENBAUM	Dissecting Scissors, TC	5	UNIVERSAL	Bone Rongeur	60
METZENBAUM (LAHEY)	Dissecting Scissors, TC	5	UNIVERSAL	Wire Cutter	46
MILLER	Bone Rasps	25	UNIVERSAL	Wire Cutter, TC	46
MINI-FRIEDMAN	Bone Rongeur	60	VAN BUREN	Bone Holding Forceps	37
MINI-HOHMANN	Bone Levers	31	VERBRUGGE	Bone Holding Forceps	42
MINI-LAMBOTTE	Chisels	48	VOLKMANN	Bone Curettes	57,59
MINI-LEXER	Chisels & Gouges	54	VOLKMANN	Retractors	15
MIXTER	Dissecting & Ligature Forceps	12	WALTON	Finger Ring Cutter	68
MIXTER-BABY	Dissecting & Ligature Forceps	12	WEITLANER	Retractors	16
MOD. USA	Plaster Cast Breaker	21	WIGMORE	Plaster of Paris Saw	21
MOLT	Periosteal Elevators	26	WILLIGER	Bone Curettes	58
MOYNIHAN	Hemostatic Forceps	11	WILLIGER	Elevators	26
NELSON (METZENBAUM)	Dissecting Scissors, TC	5	WILLIGER	Mallets	24
OLIVECRONA	Bone Rongeur	61	WILLIGER	Raspatories	26
OMBERDANNE	Mallet	24	WOLFF	Plaster Cast Breaker	21
PARTSCH	Chisels & Gouges	48	YANKAUER	Suction Tubes	2
PARTSCH	Mallet	23	ZAUFAL-JANSEN	Bone Rongeur	64
PEAN	Hemostatic Forceps	11			
POOLE	Suction Tubes	2			
POTTS-SMITH	Dissecting Forceps, TC	7			
PUTTI	Bone Files	25			
RADOLF	Nail Pulling Forceps	68			
RANKIN-CRILE	Hemostatic Forceps	8			
RANKIN-KELLY	Hemostatic Forceps	8			
REINER	Plaster of Paris Knife	21			
ROCHESTER-OSCHNER	Hemostatic Forceps	10			
ROCHESTER-PEAN	Hemostatic Forceps	9			
RUSKIN	Bone Rongeur	63,64,67			
RUSKIN-LISTON	Bone Cutting Forceps	36			
RUSKIN-MINI	Bone Rongeur	64			
RUSKIN-ROWLAND	Bone Cutting Forceps	36			
RYDER (FRENCH EYE)	Needle Holders, TC	14			
SATTERLEE	Amputation Saw	44			
SCHEDE	Bone Curettes	57			
SCHELL	Bone Rongeur	61			
SCHIMMELBUSCH	Sterilizing Dressing Drums	17			
SEDILLOT	Raspatories	27			
SEMB	Bone Cutting Forceps	36			
SEMB	Bone Holding Forceps	39			
SEMB	Bone Rongeur	67			
SEMB	Raspatories	28			
SENN-MUELLER	Retractors	15			
SEUTIN	Bandage Scissors	20			
SMILLIE	Knee Retractors	33			
SMILLIE	Meniscotomes	54			
SMITH-PETERSON	Bone Rongeurs	63			
SMITH-PETERSON	Chisels & Gouges	52			
SPRATT	Bone Curettes	56			
STELLBRINK	Bone Rongeurs	63			